



CARDO

# FREECOM 4+

**NL SNELSTARTGIDS**



OPERATED BY  
**NATURAL VOICE**

SOUND BY



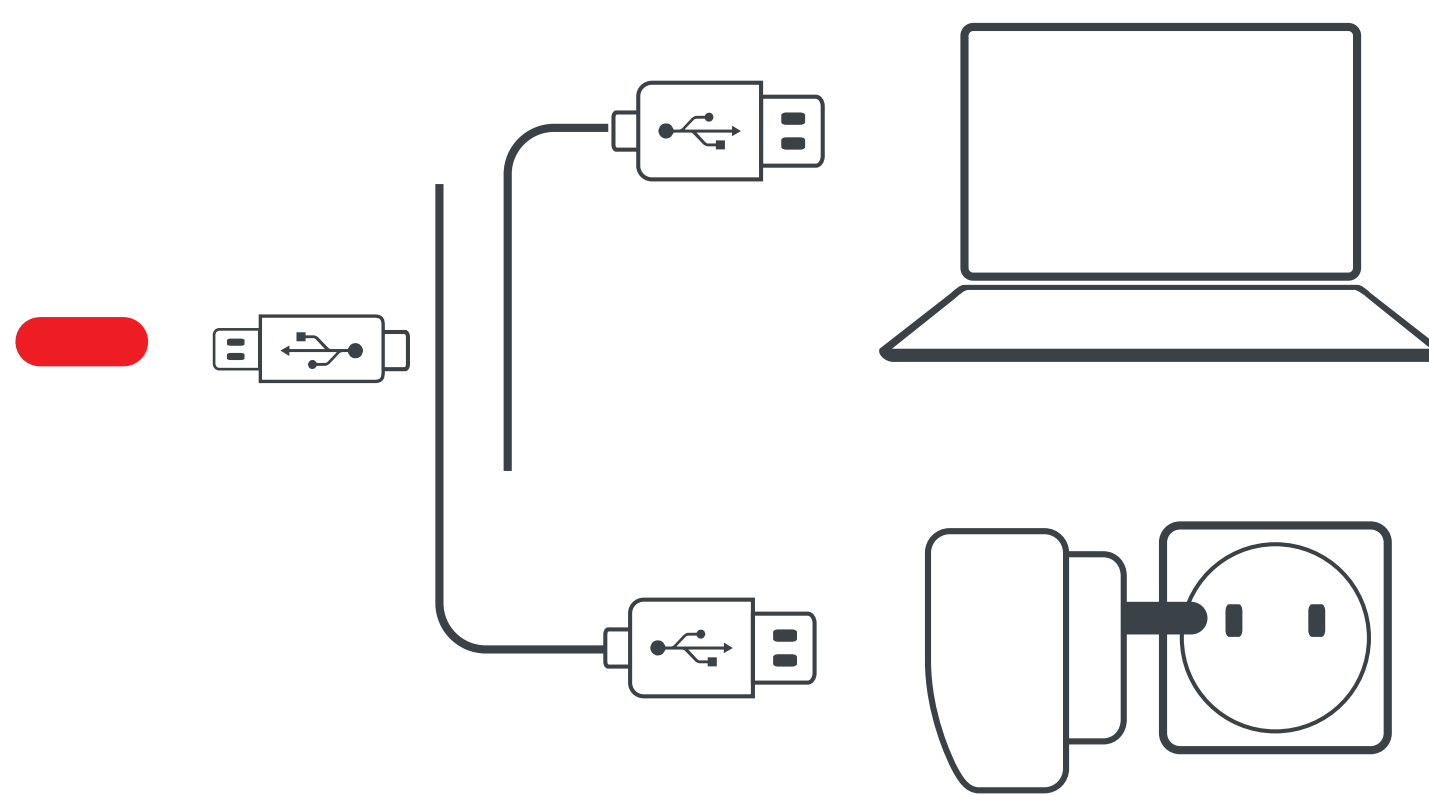
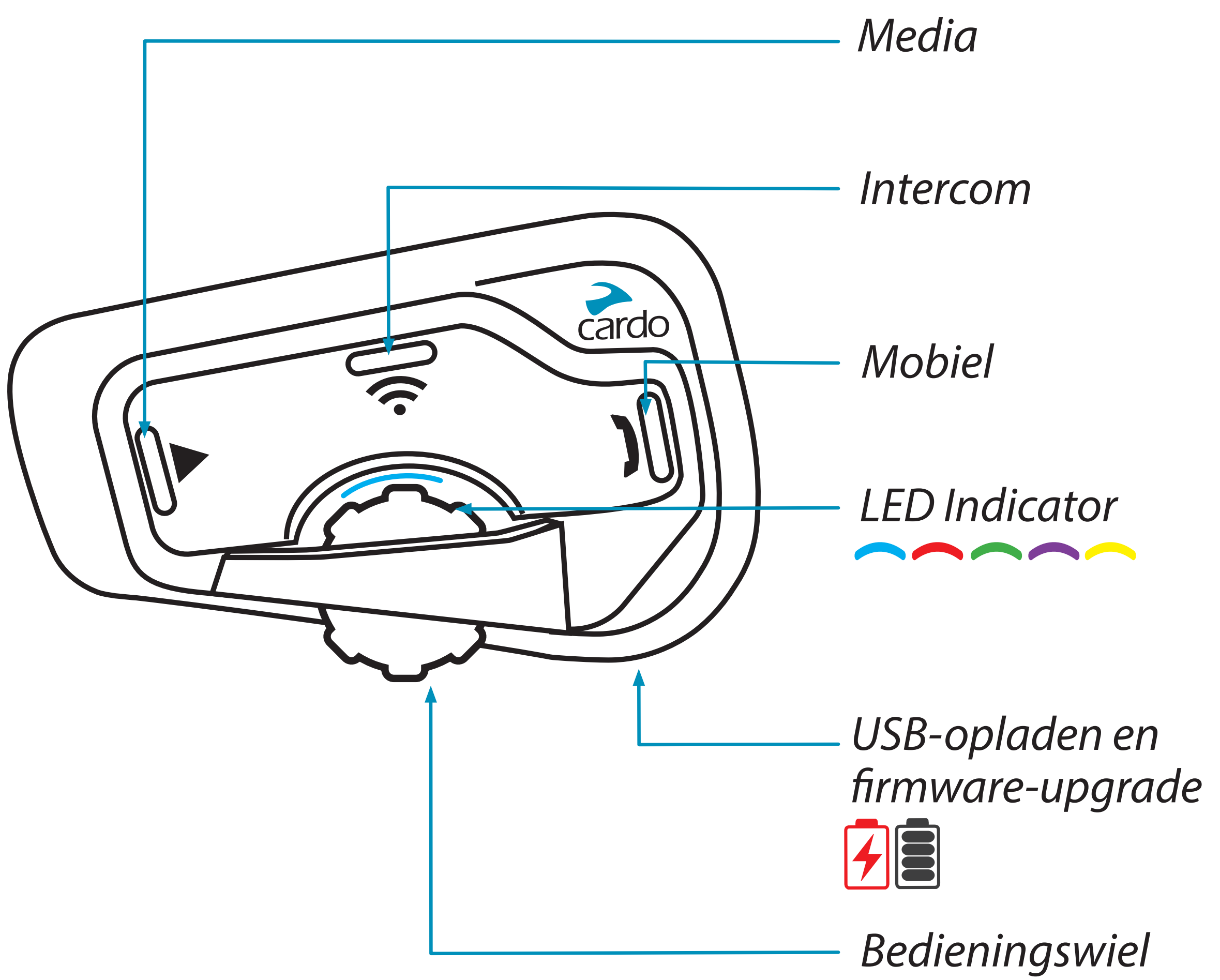

*De standaardtaal is Engels.  
Taal kan worden gewijzigd via de Cardo Connect-app*

# Aan de slag



Aan / Uit

1 Sec.

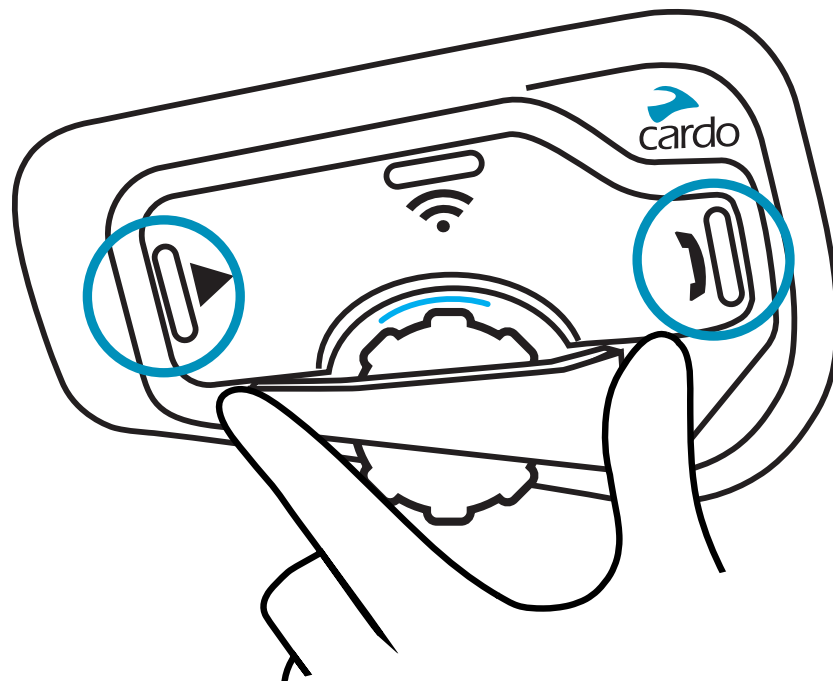

Mute / Unmute

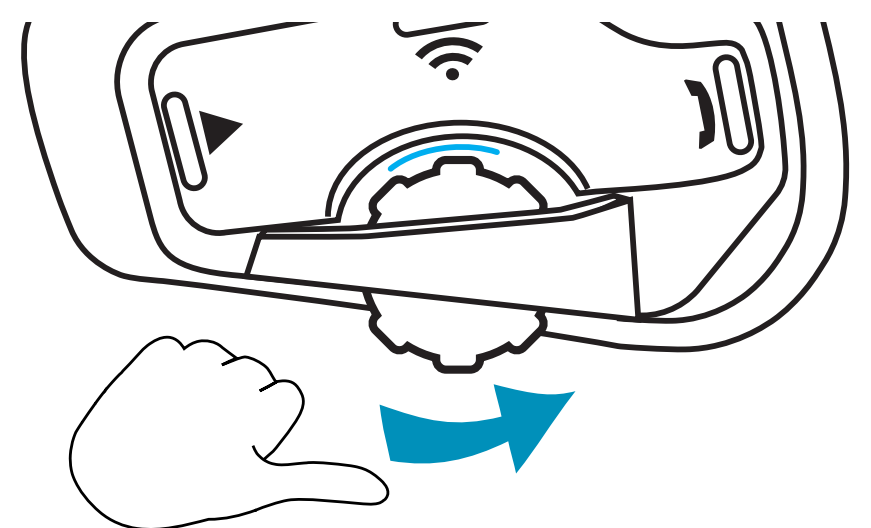
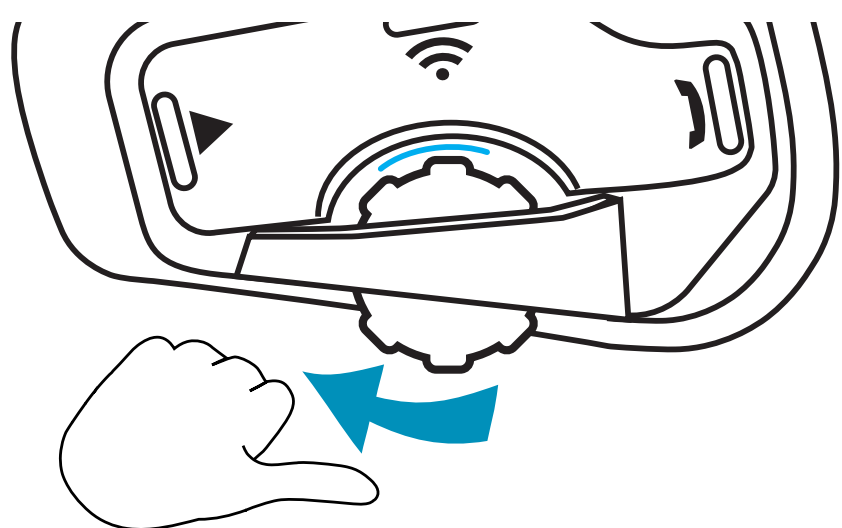
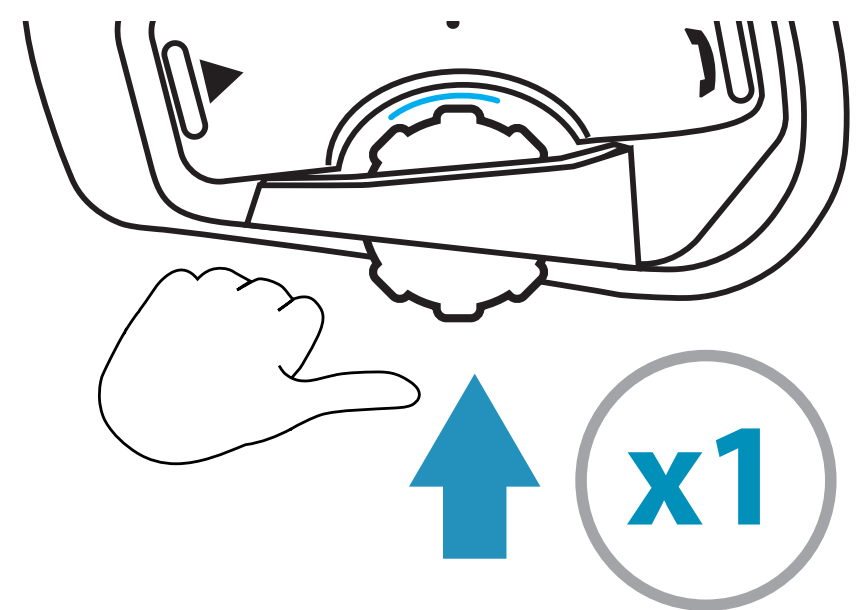
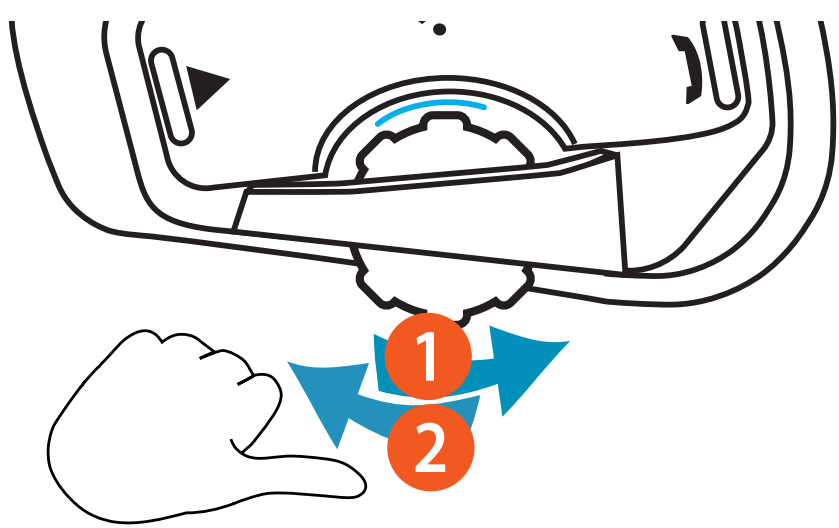
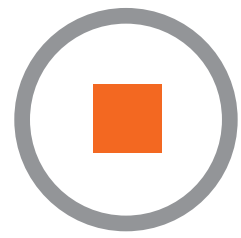

Gebruik tijdens opladen

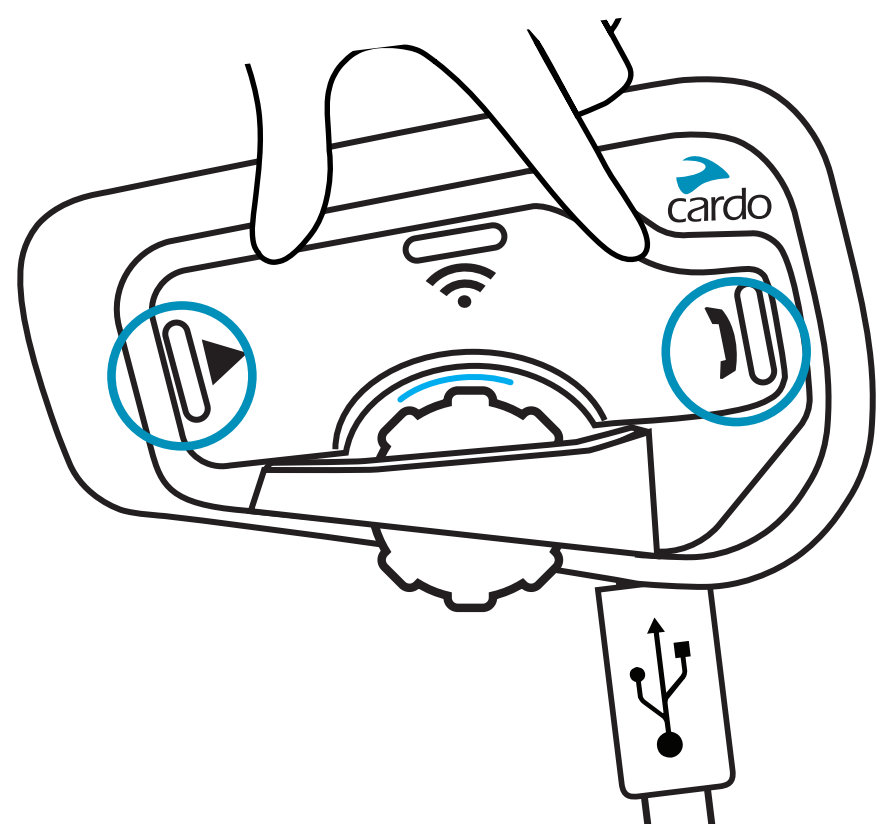
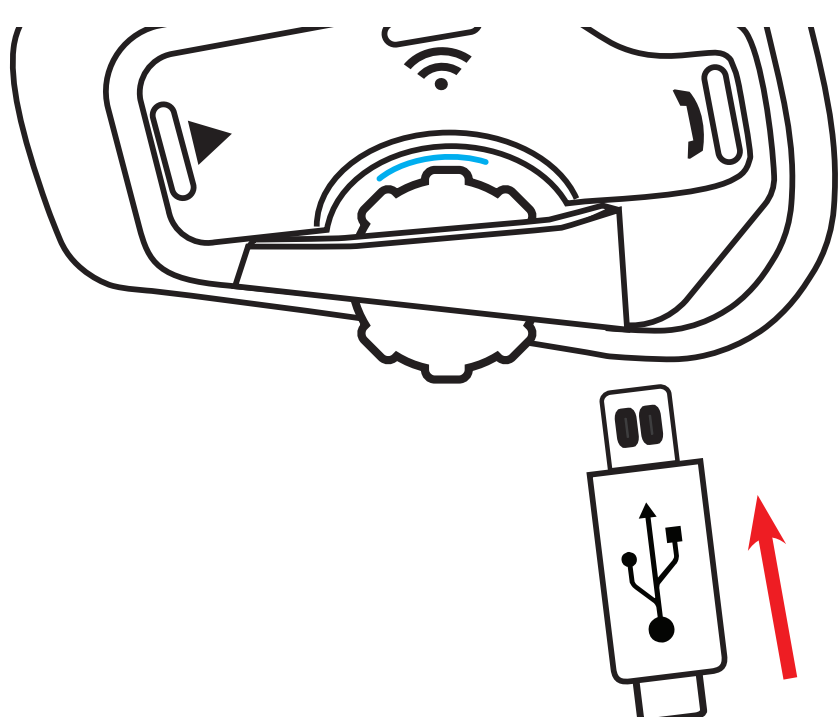

# Mobiele apparaten koppelen

## 1 Initieer

5 Sec.

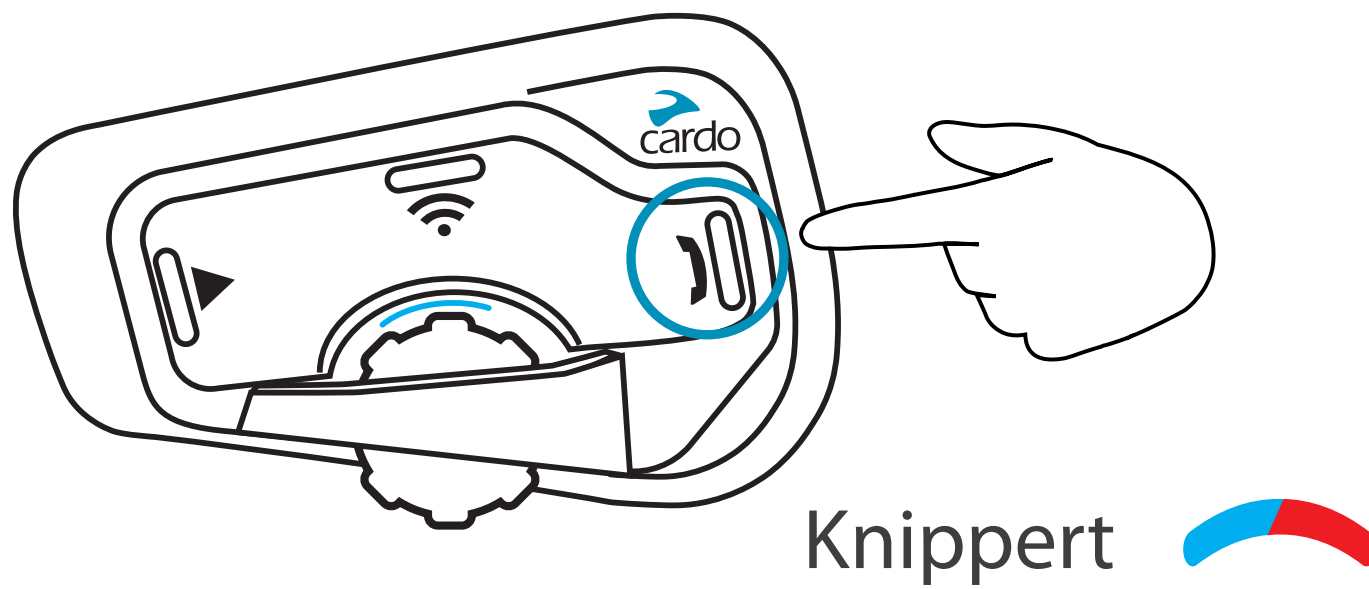

## 2 Telefoon koppelen

Zoeken naar  
Bluetooth-  
apparaten

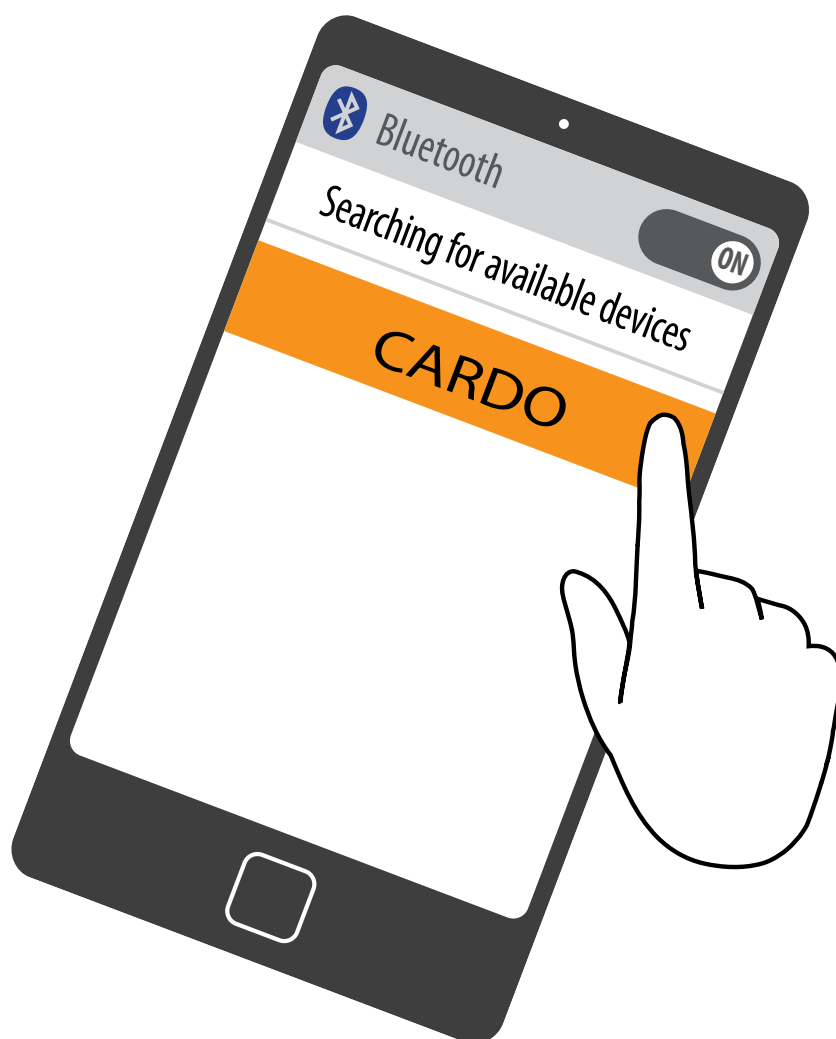

Annuleer het koppelen

5 Sec.

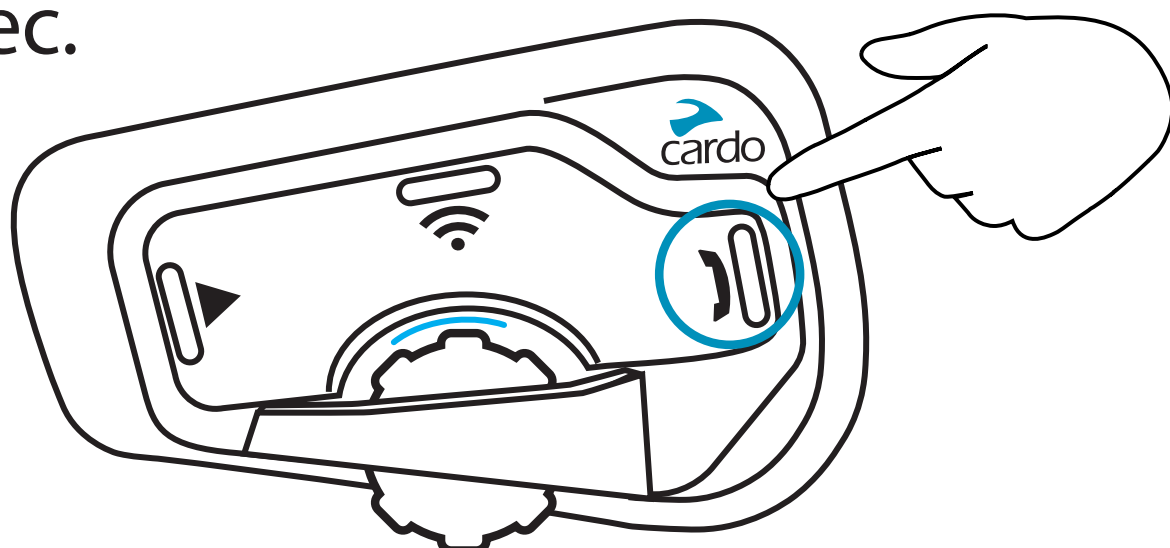

END

Succesvol

Knippert





# Mobiele apparaten koppelen

## 1 Initieer

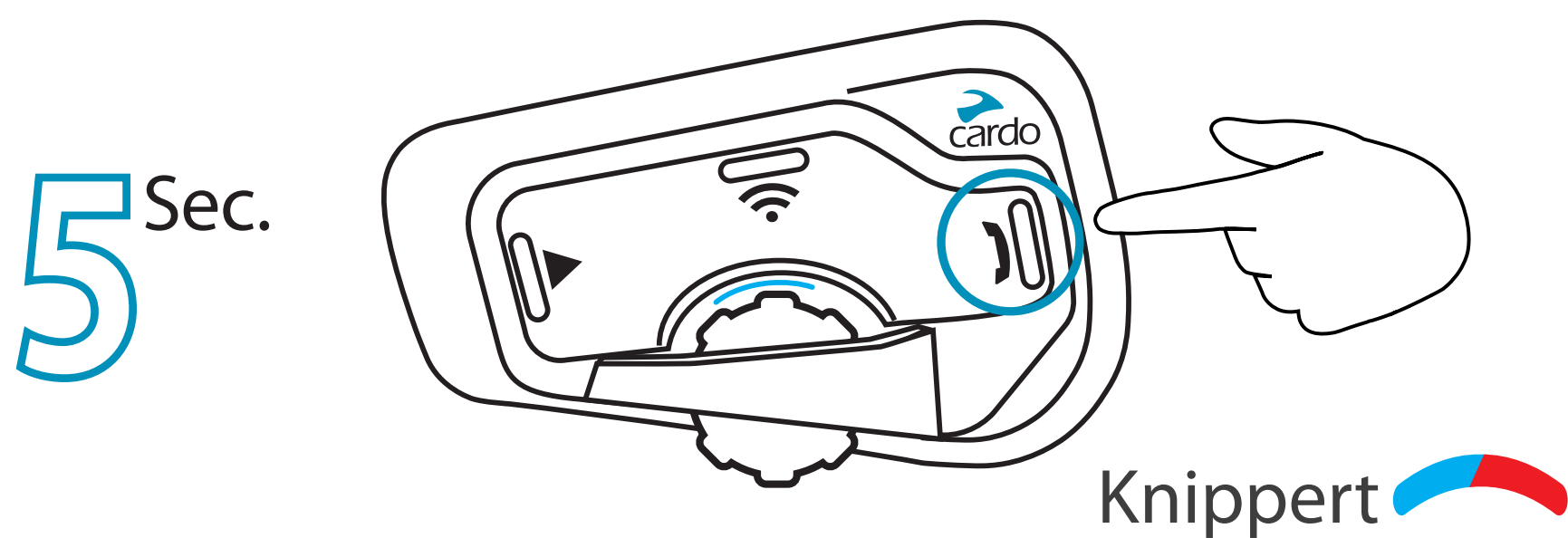

## 2 Een 2e telefoon / GPS toevoegen

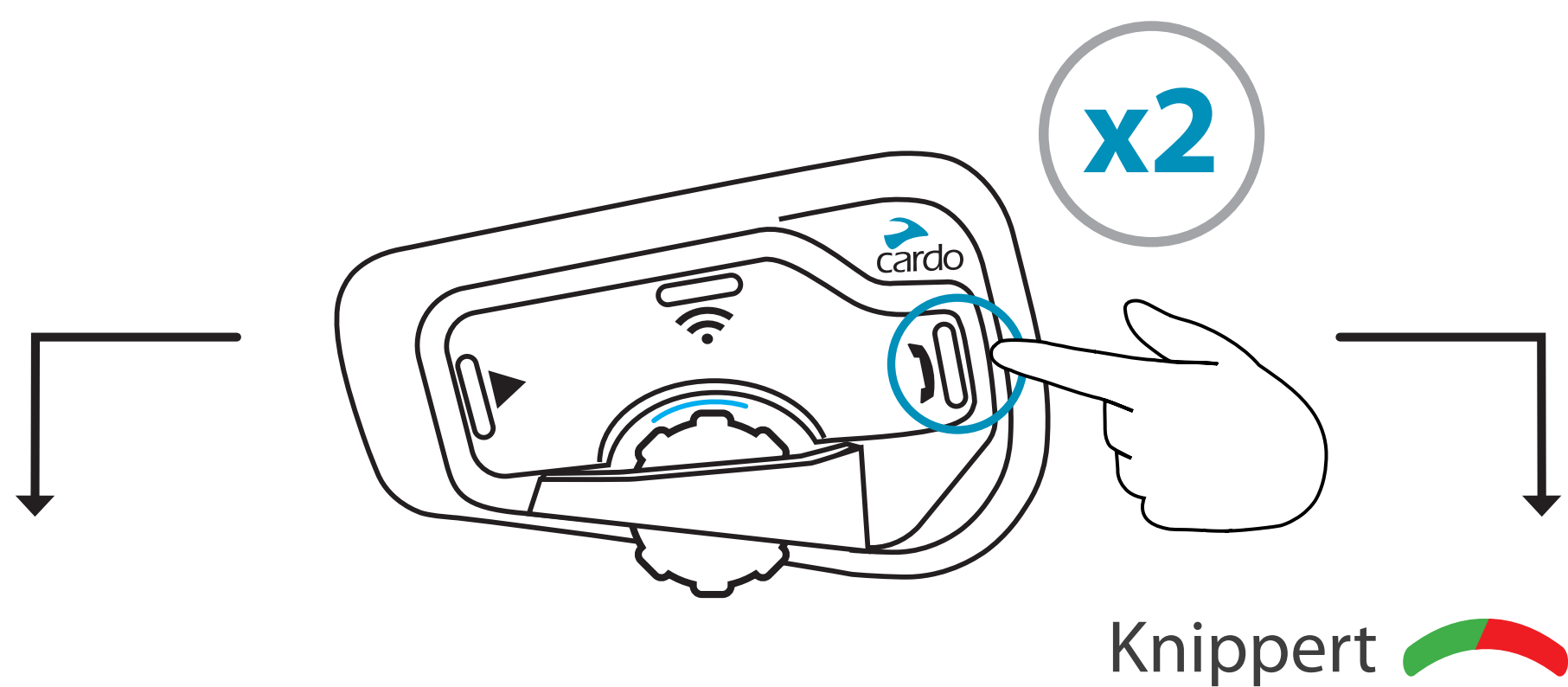

## 3 Telefoon koppelen

Zoeken naar Bluetooth-apparaten



## 3 Koppelen GPS



Led knippert langzamer



Bluetooth-apparaten zoeken op de GPS



END

Succesvol

Knippert



# Telefoonfuncties



## Beantwoord een oproep

---

Druk op een knop

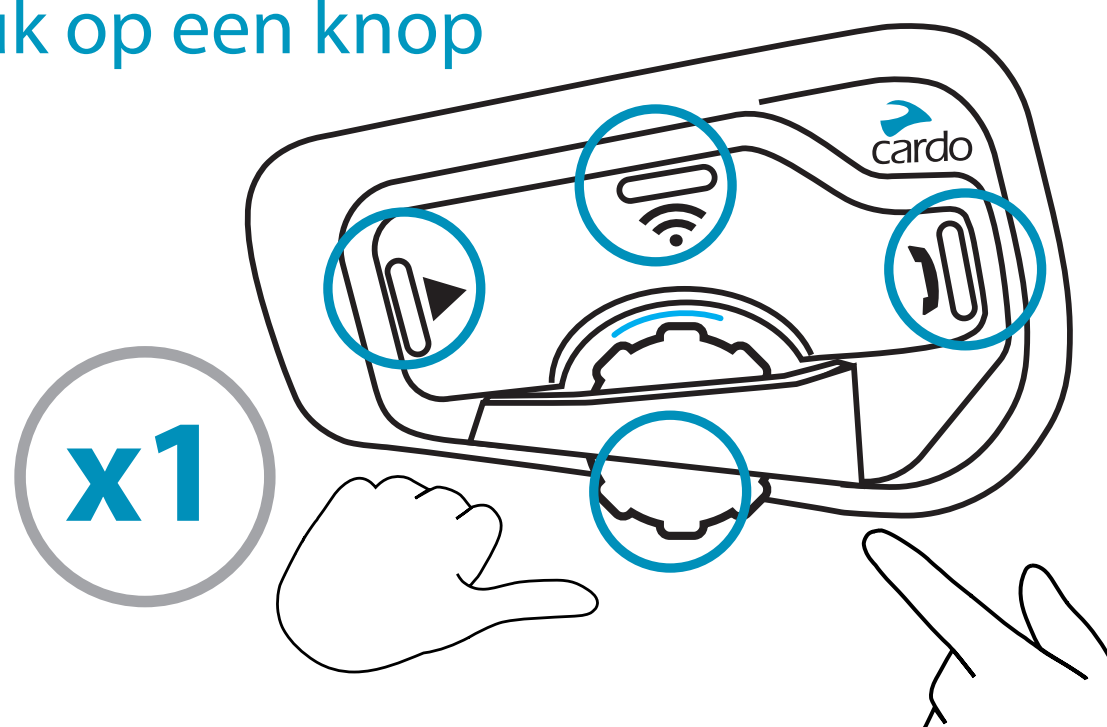

## Een oproep negeren

---

Scrol met het bedieningswiel

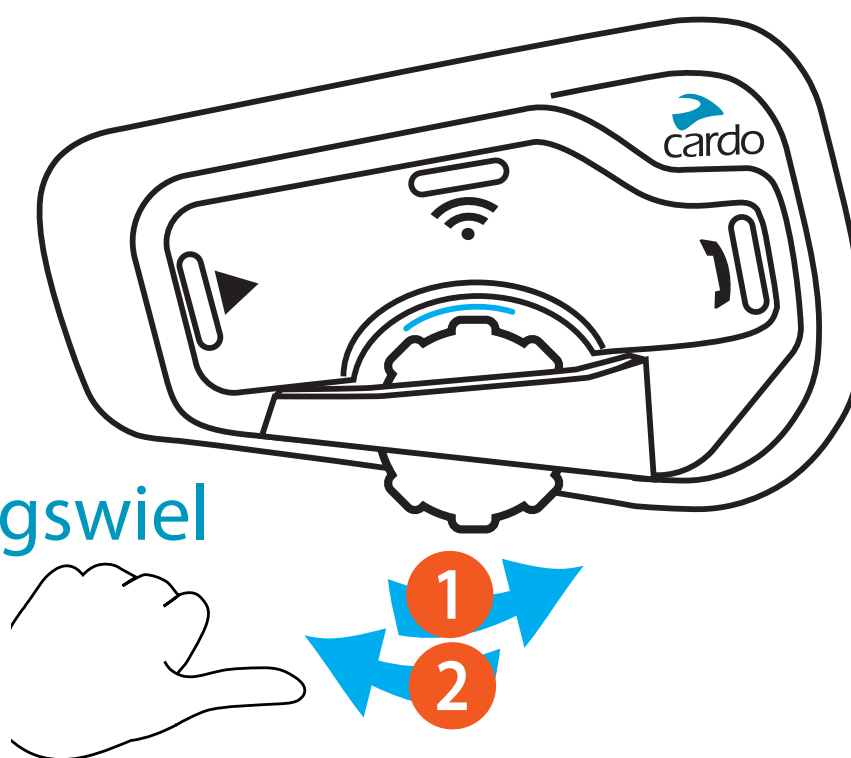

## Een oproep weigeren

---

Een van deze knoppen

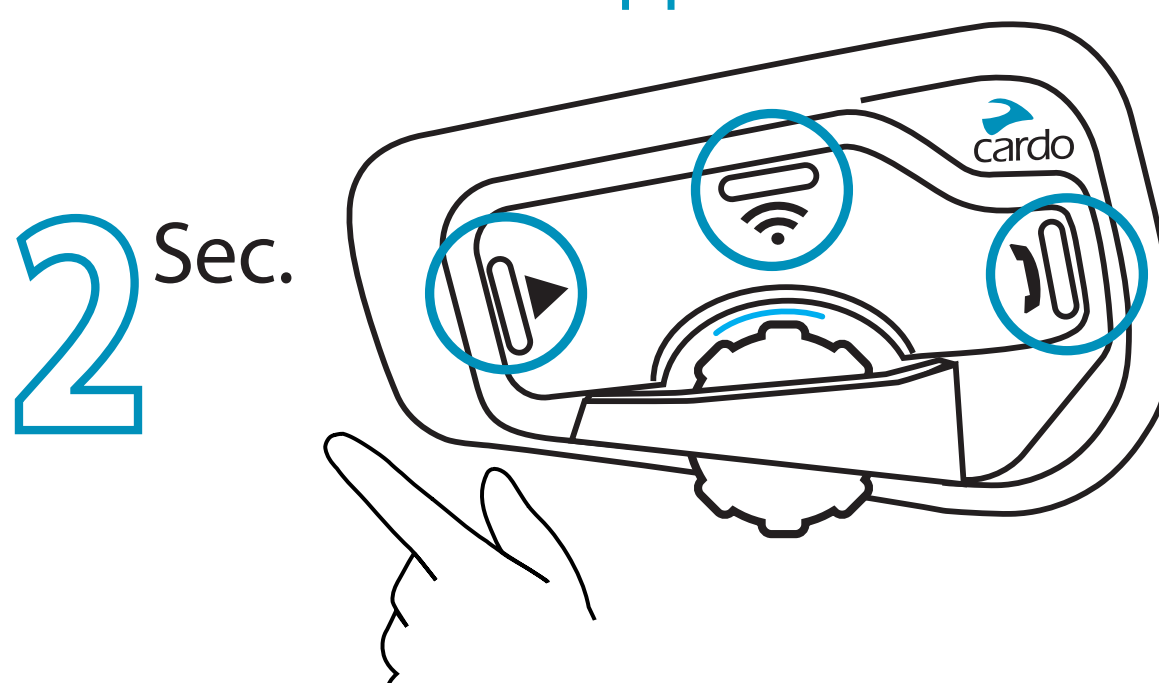

## Een gesprek beëindigen

---

Een van deze knoppen

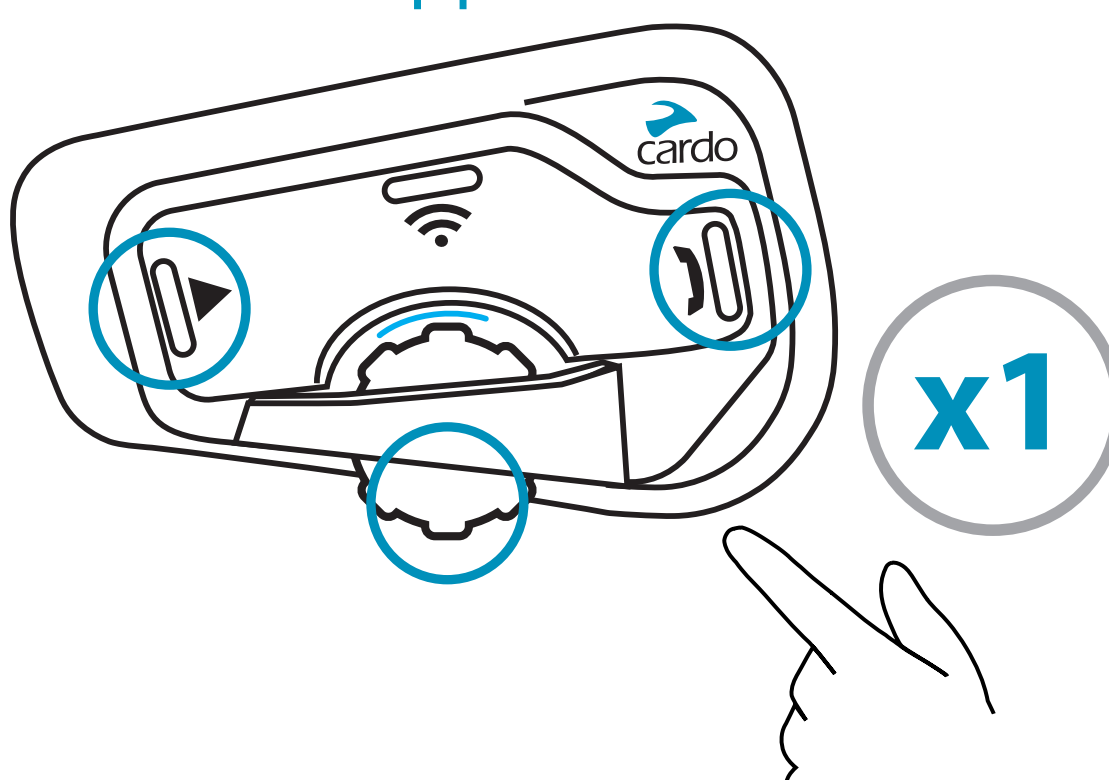

# Telefoonfuncties



## Telefoongesprek

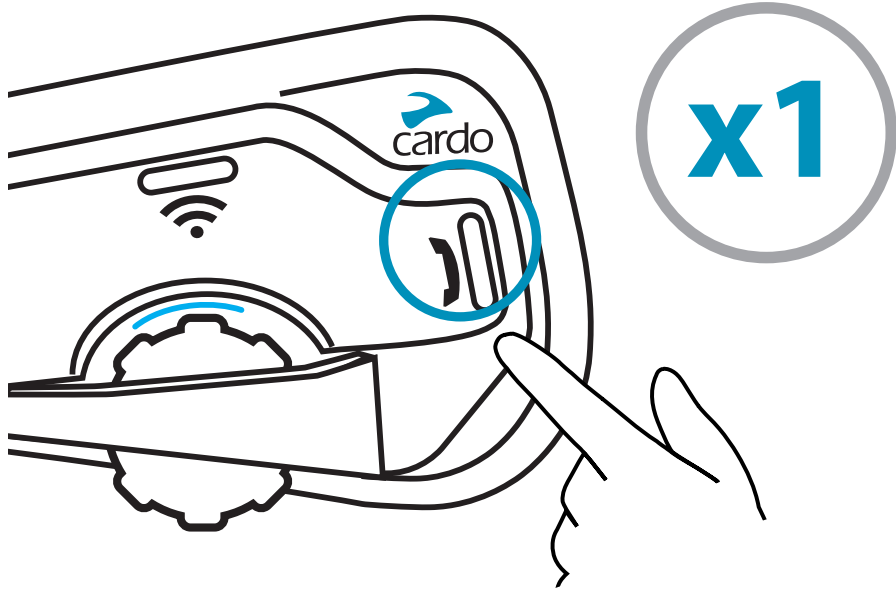

## Nummerherhaling

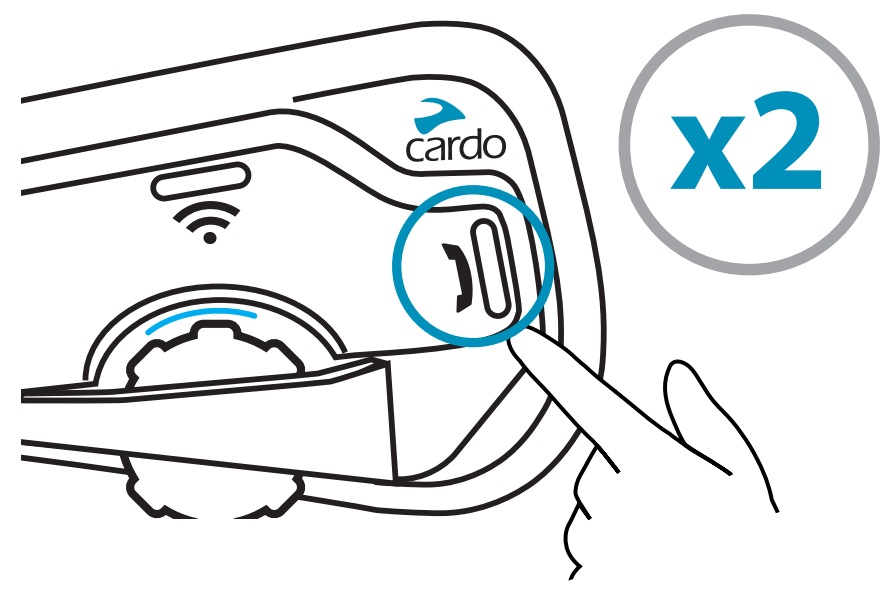

## Snelkiezen

Ingesteld via app

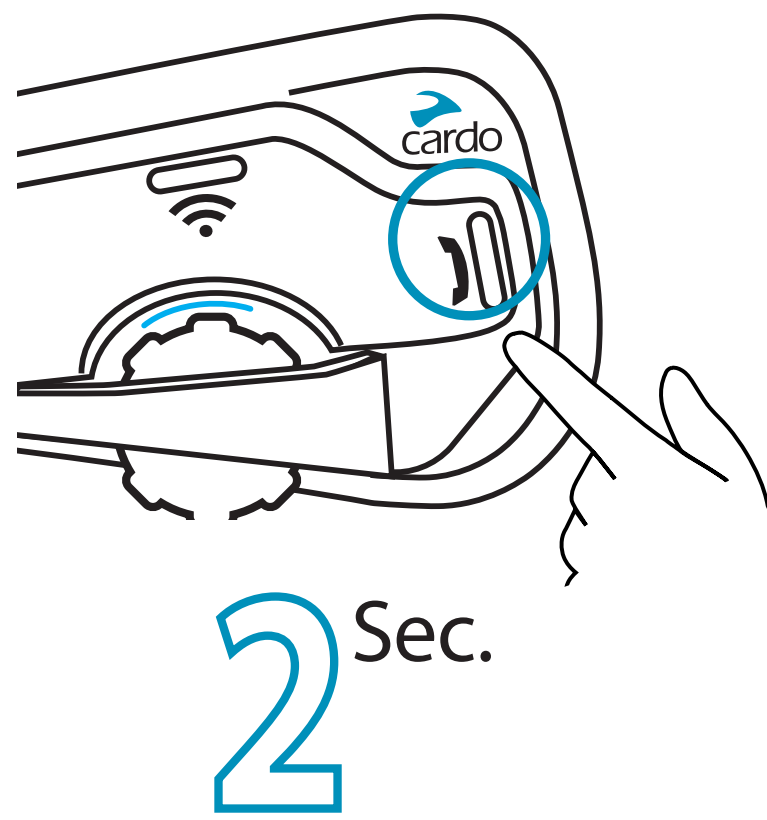

## Deel actief telefoongesprek

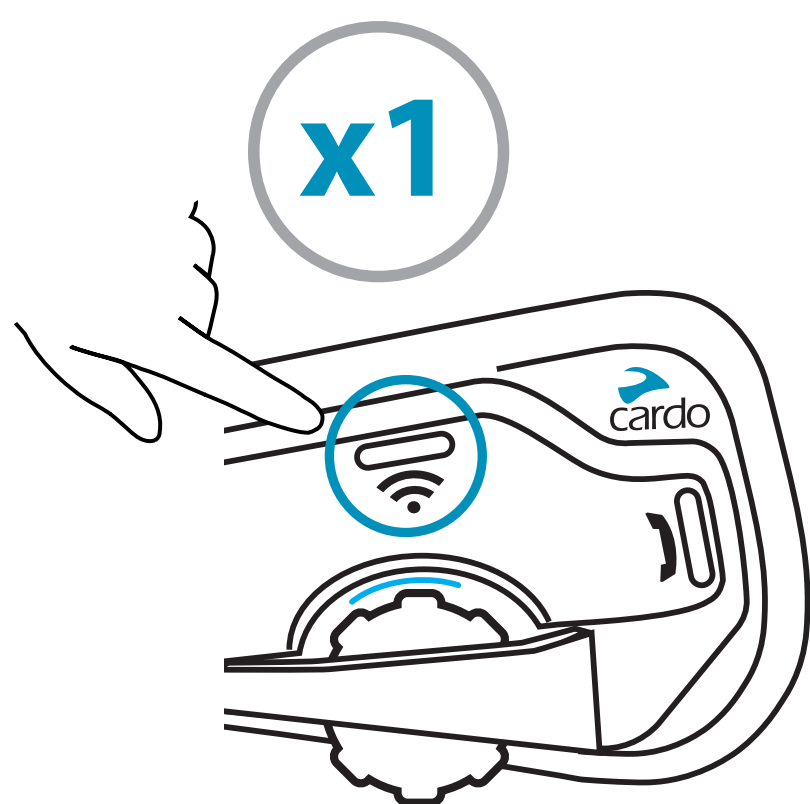

*Deel met rijder 1*



*Deel met rijder 2*

# Audio

## FM Radio



Aan

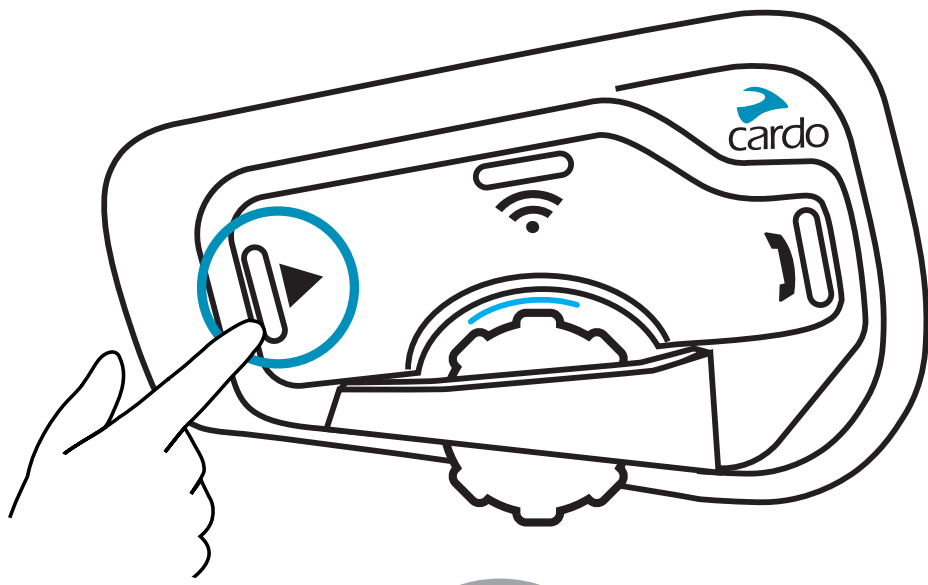

x2



Uit

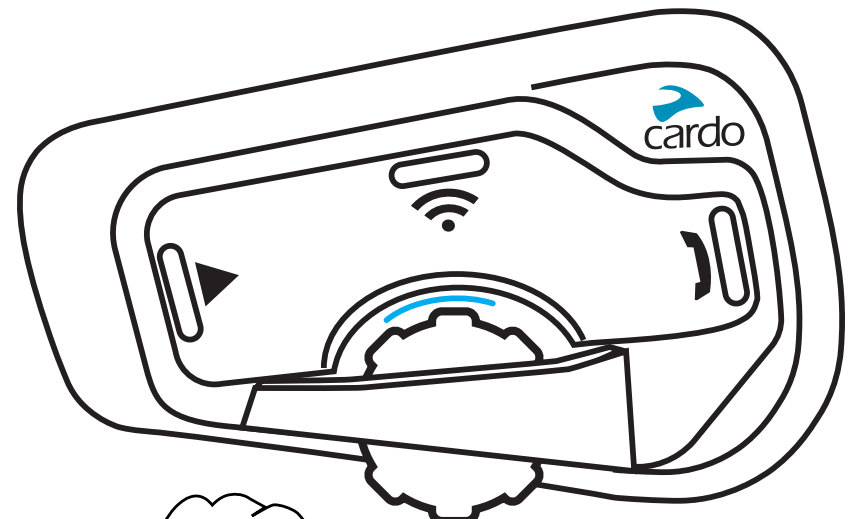

x1



Vorige

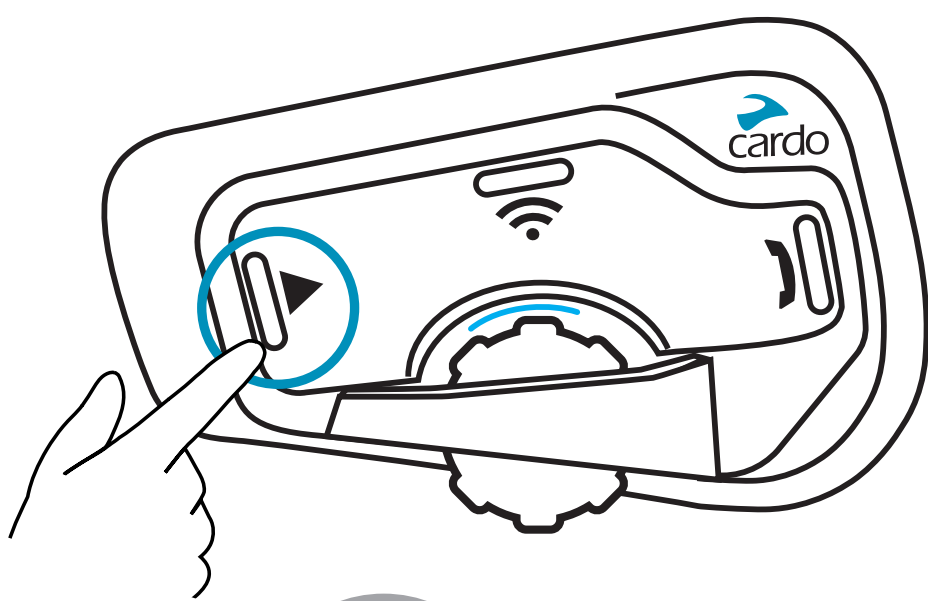

x2



Volgende

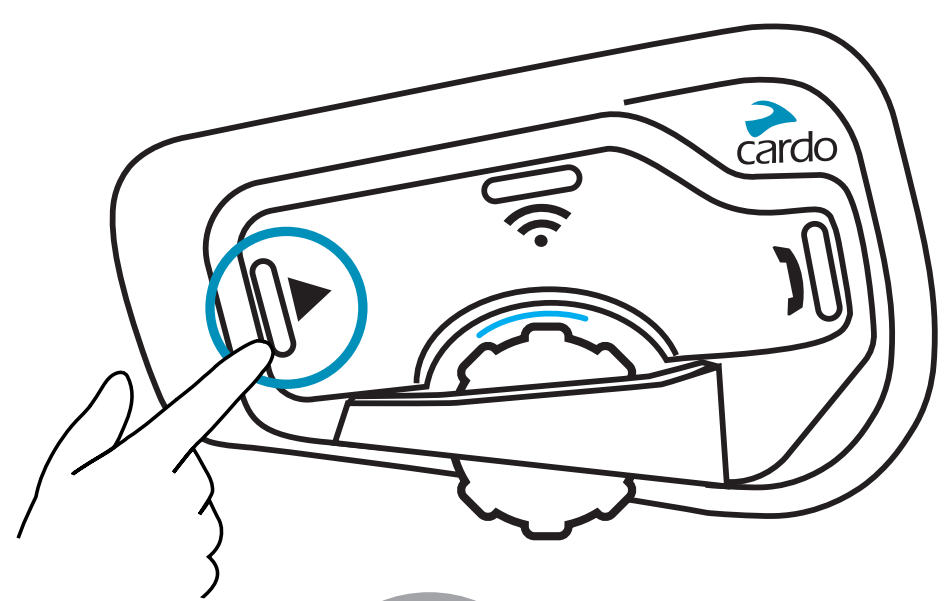

x1



Auto Scan

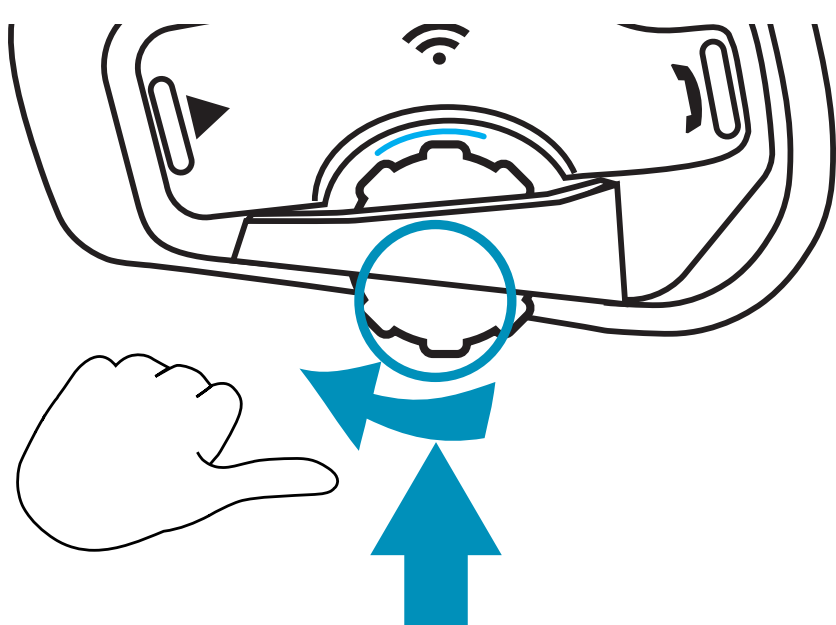

Drukken en scrollen

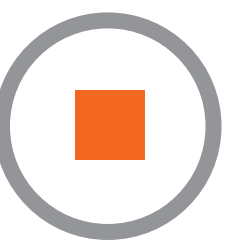

Stop Scan

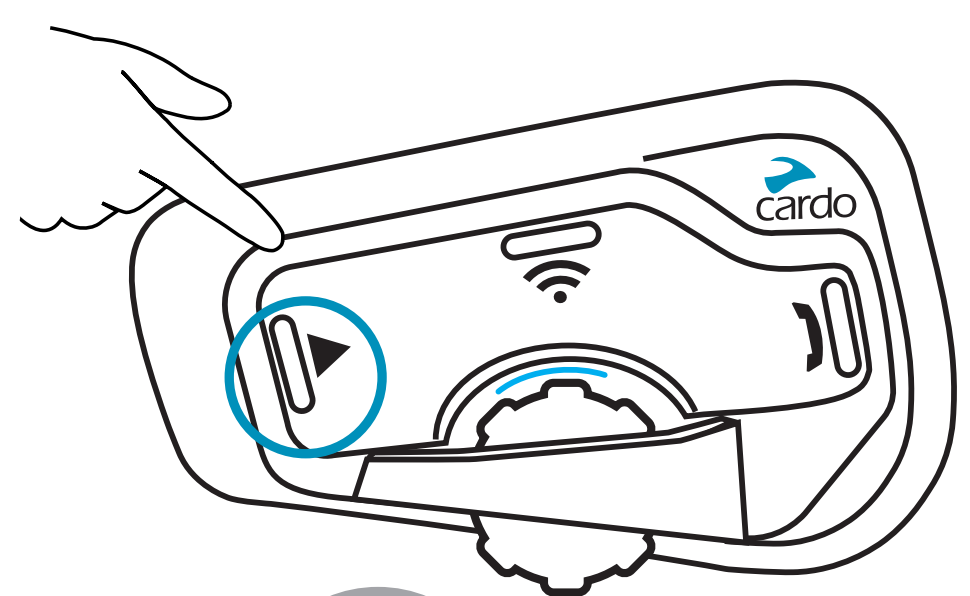

x1



# Audio

## Muziek



Aan



Uit

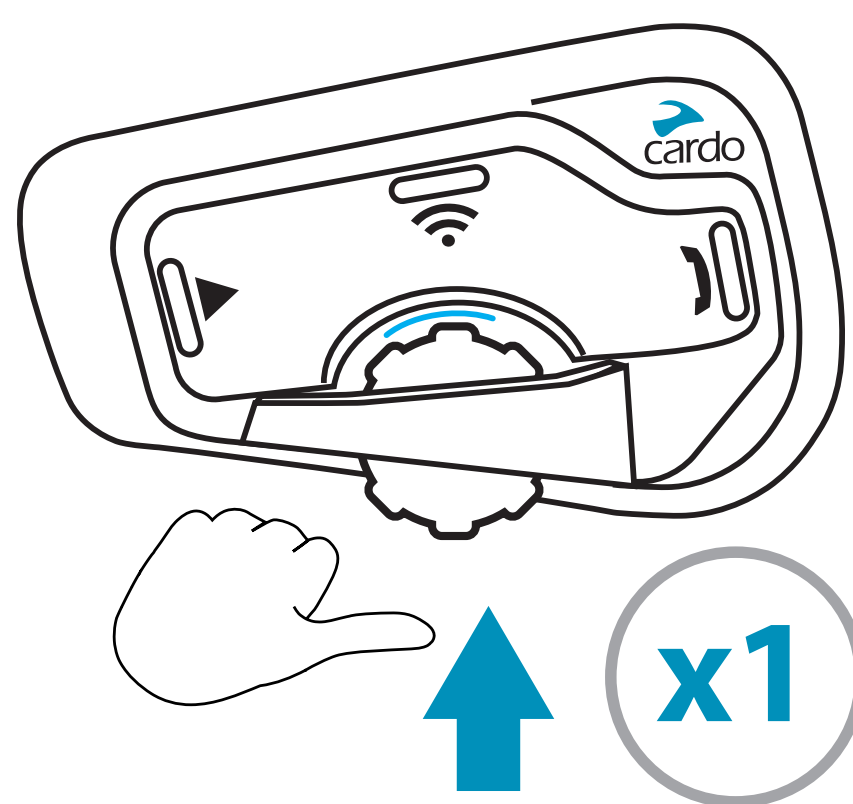
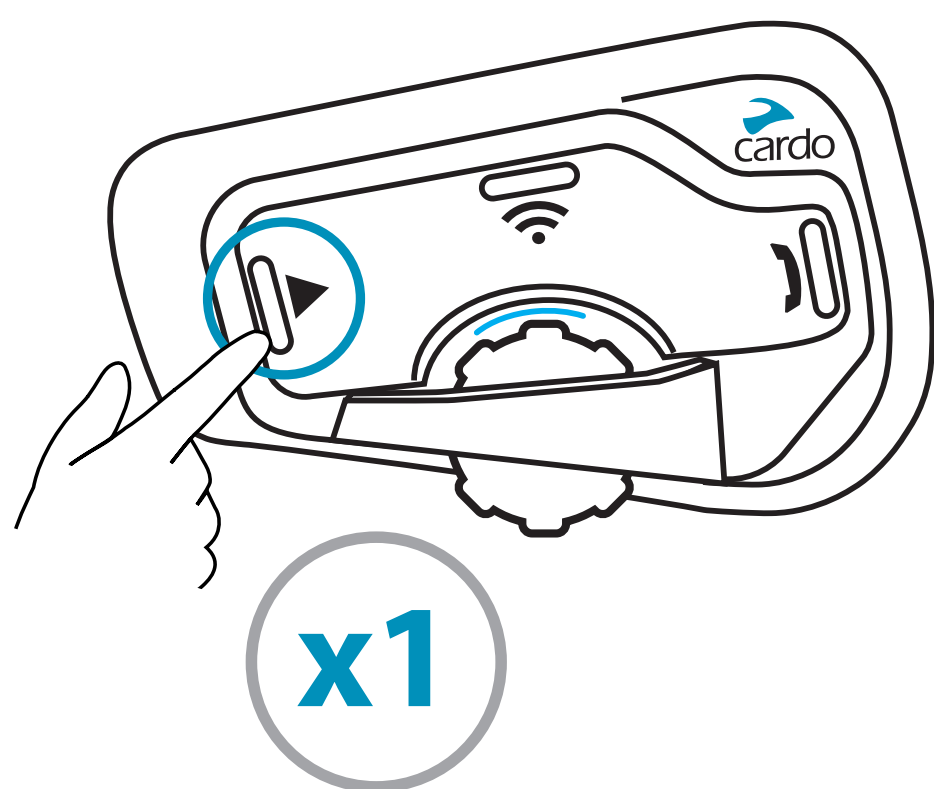

Vorige



Volgende

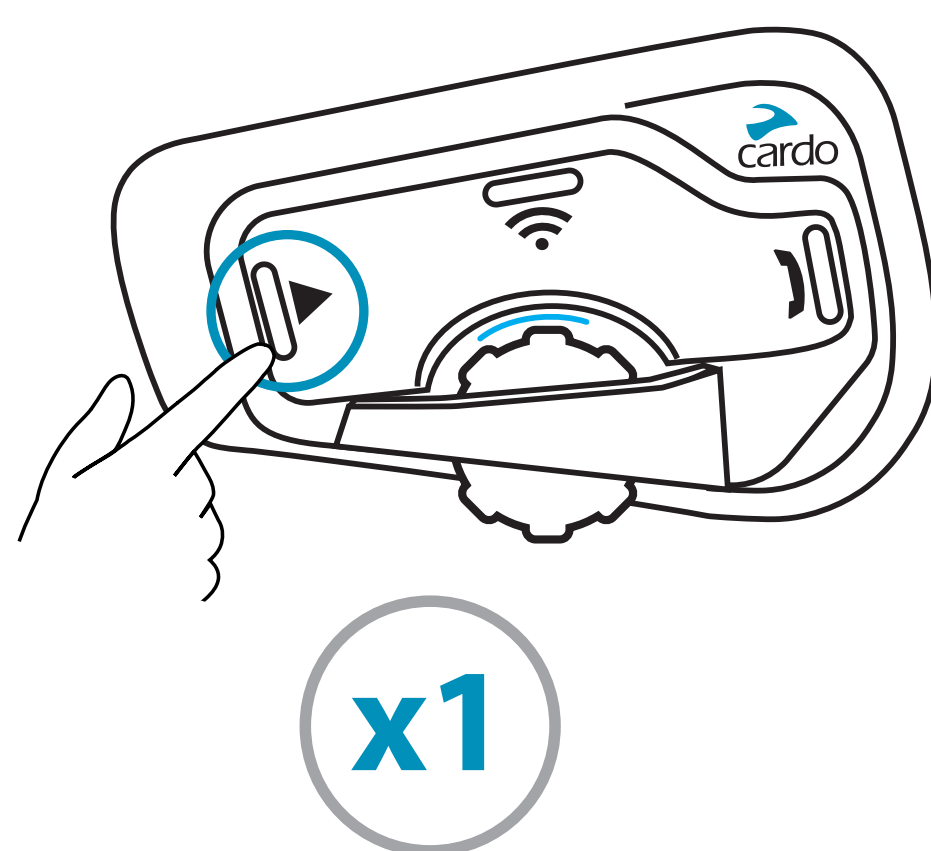
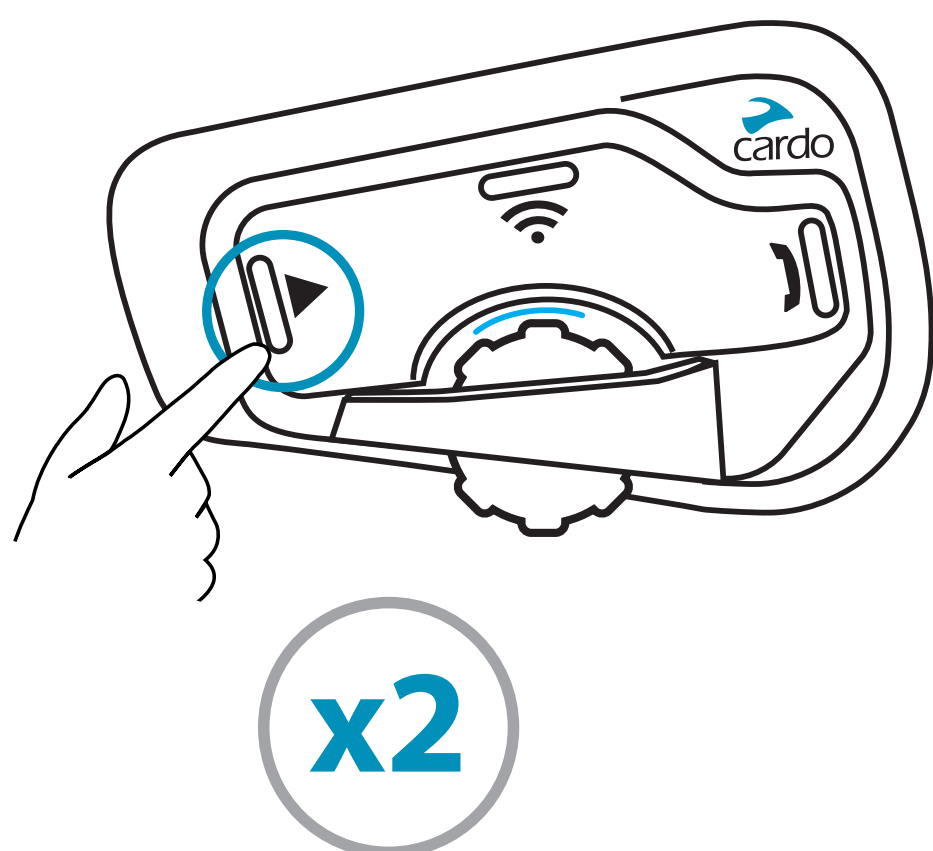

## FM/Muziektoets

2 Sec.

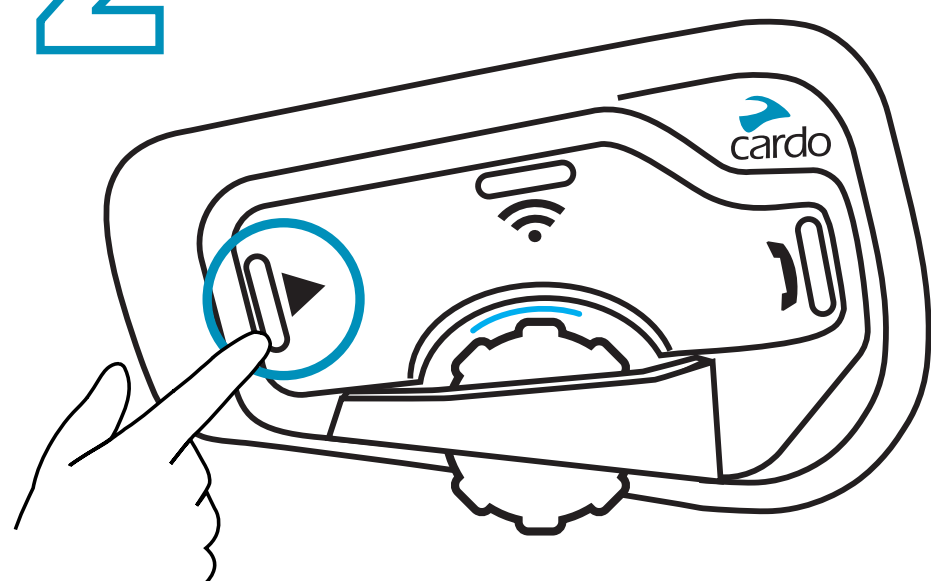

## Audio Delen

2 Sec.

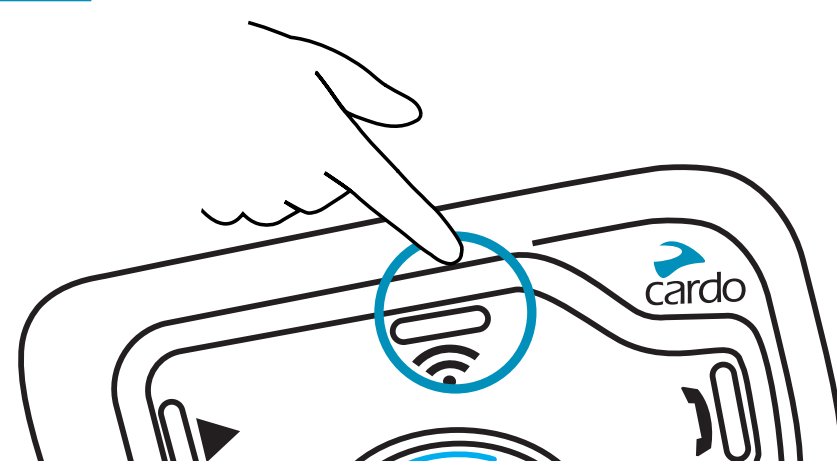

Delen starten/stoppen

# Cardo Intercom Instellen

## 2-weg koppeling

5 Sec.

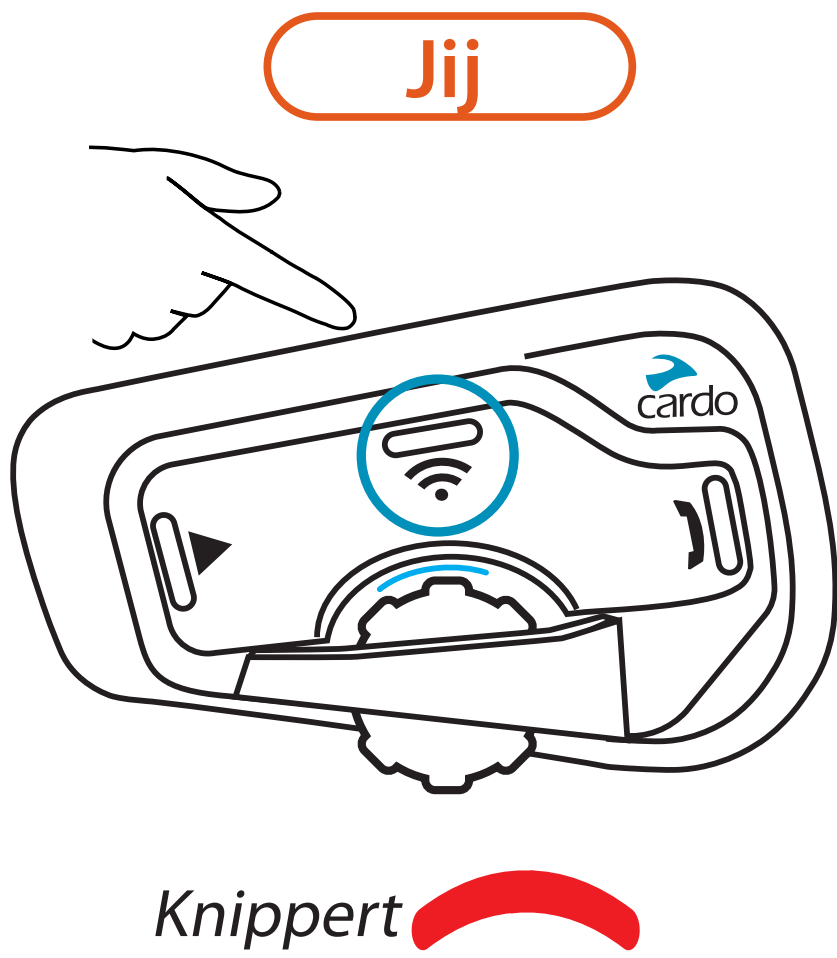

Start intercom-koppeling

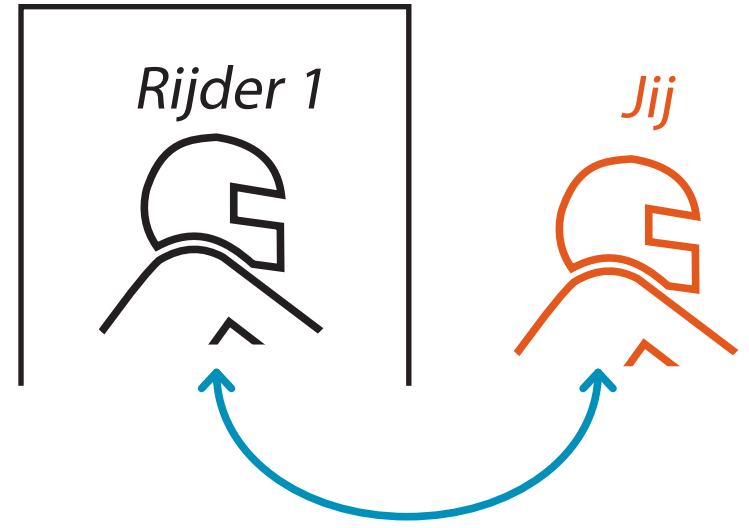

## Toevoeging van 3e rijder

5 Sec.

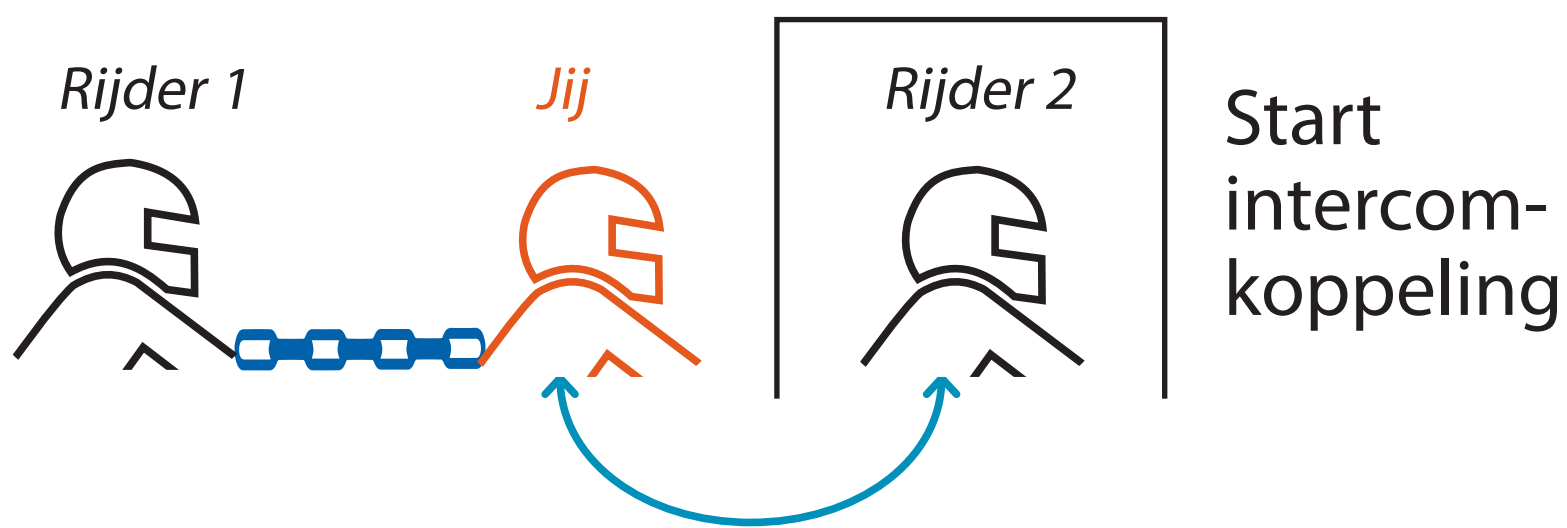
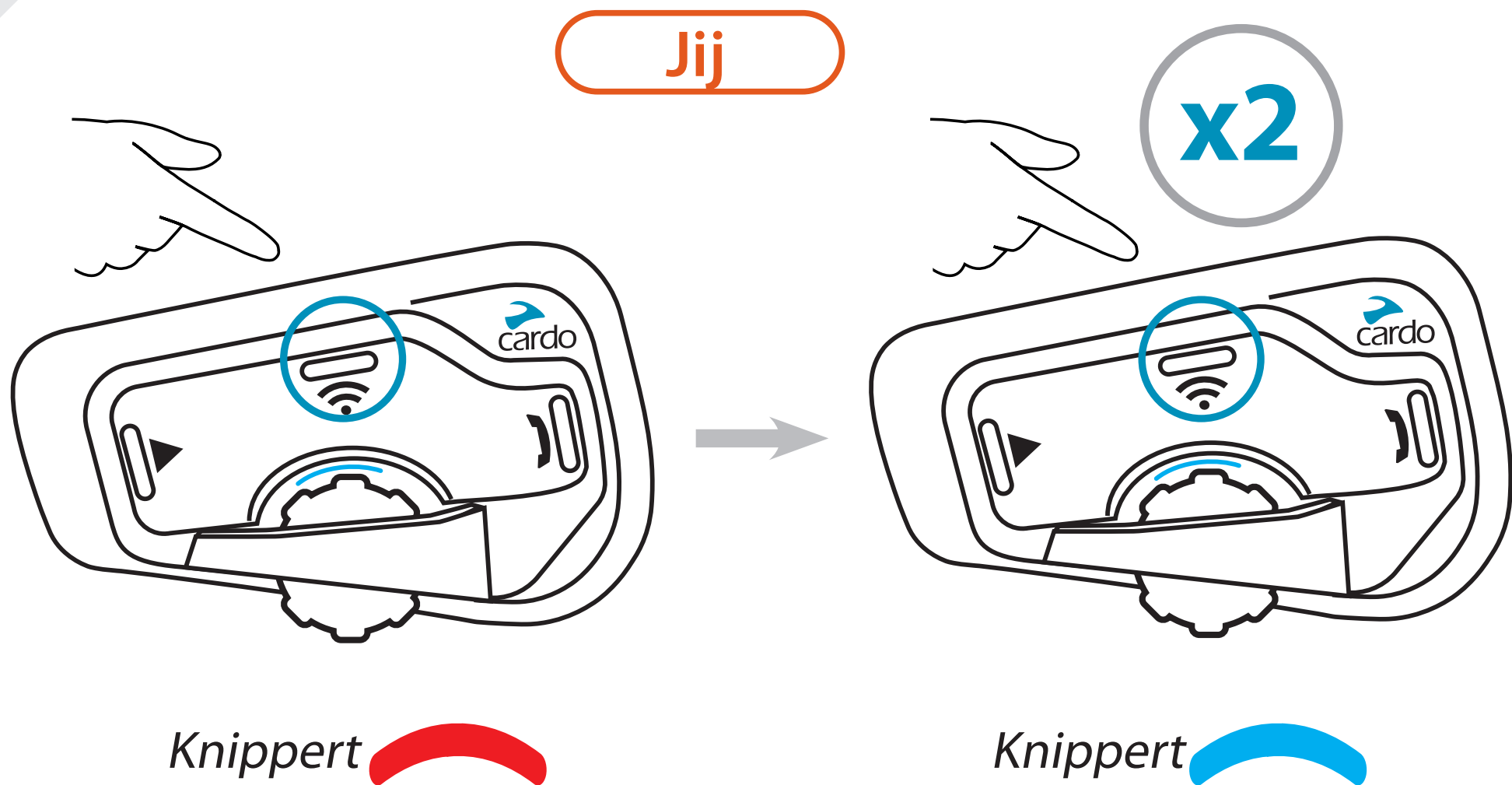

## Toevoeging van 4e rijder

Rijder 2 maakt verbinding met rijder 3 op het vrije kanaal van rijder 2

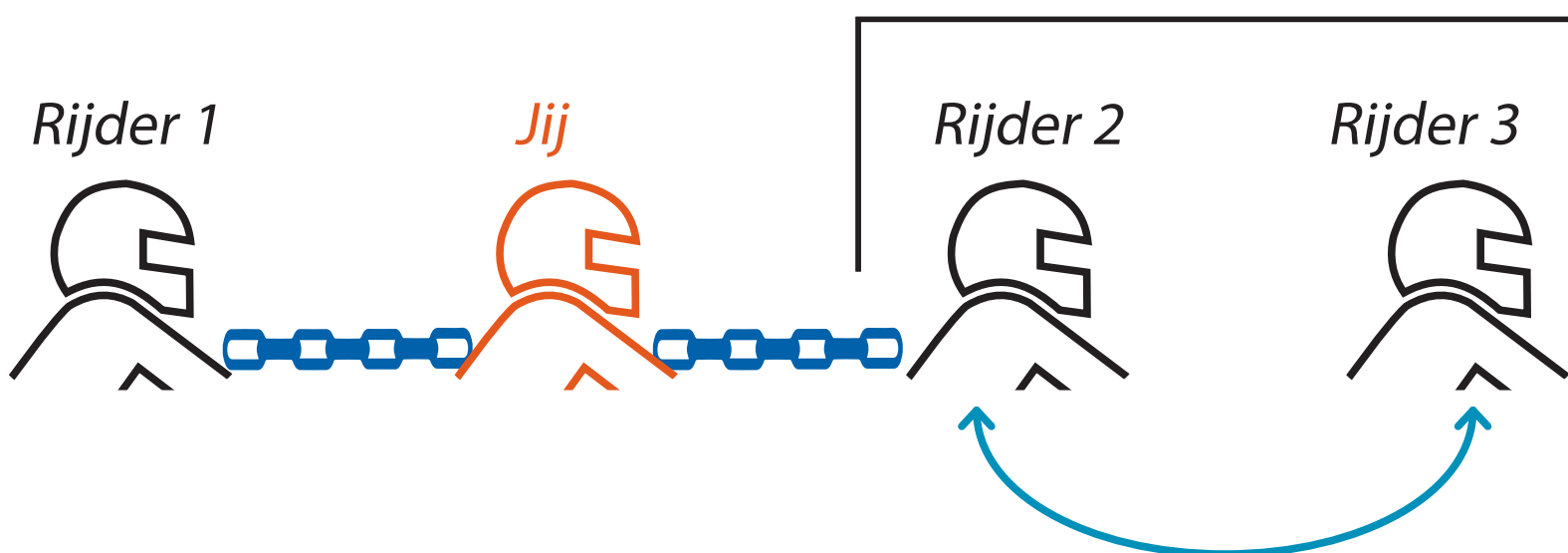

# Toetreden Tot/Aanmaken van een Niet-Cardo Intercomgroep

## 2-weg koppeling

Jij

5 Sec.

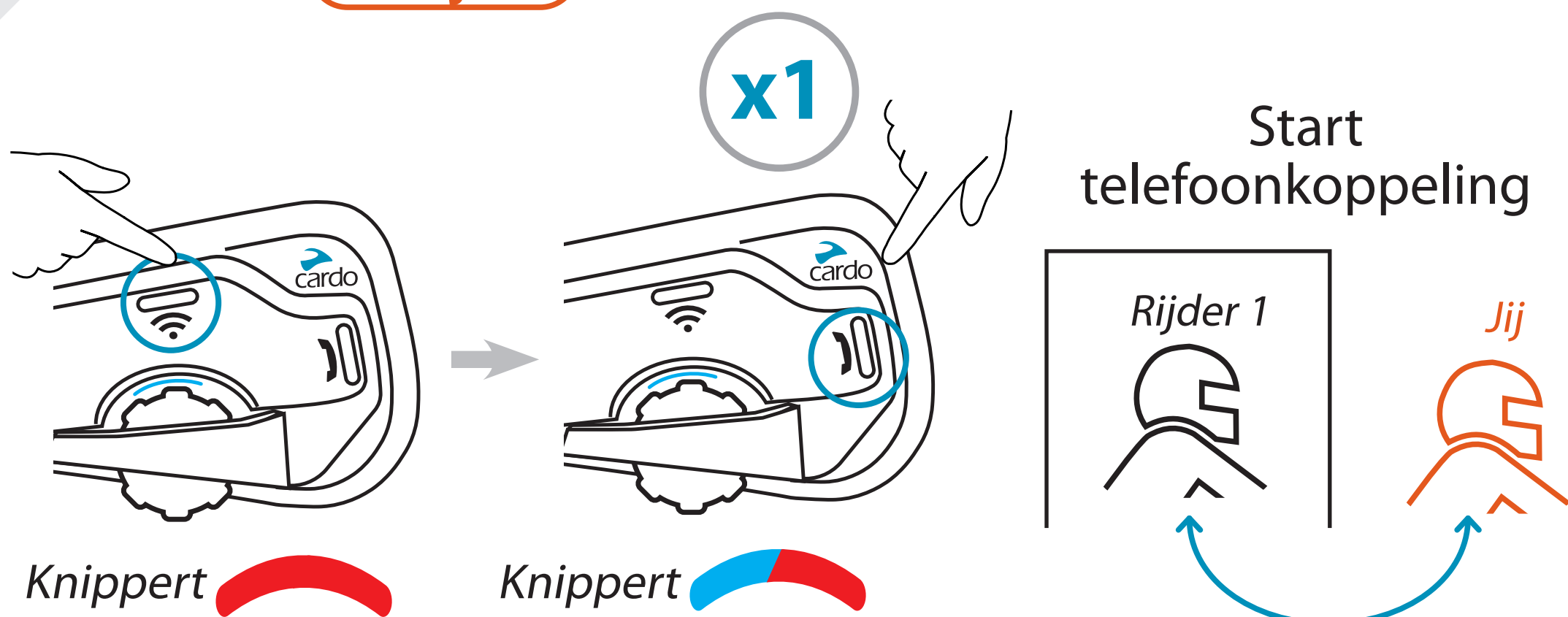

## Toevoeging van 3e rijder

Jij

5 Sec.

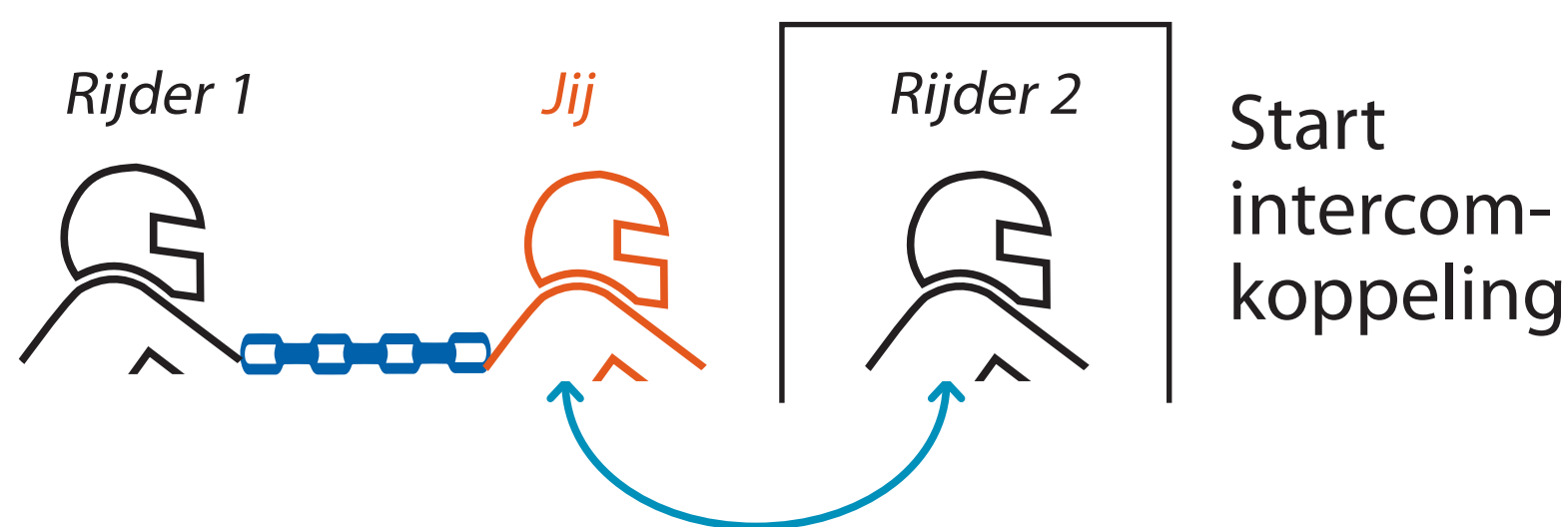
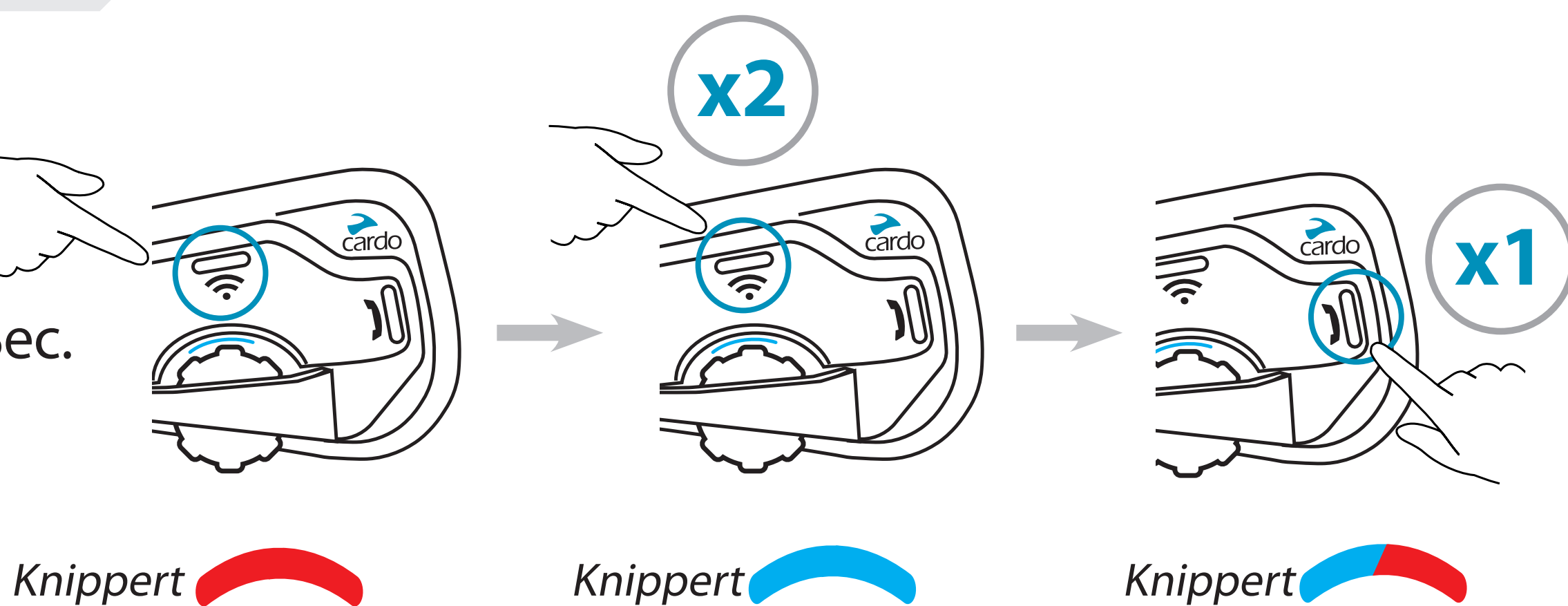

## Toevoeging van 4e rijder

Rijder 2 maakt verbinding met rijder 3 op het vrije kanaal van rijder 2

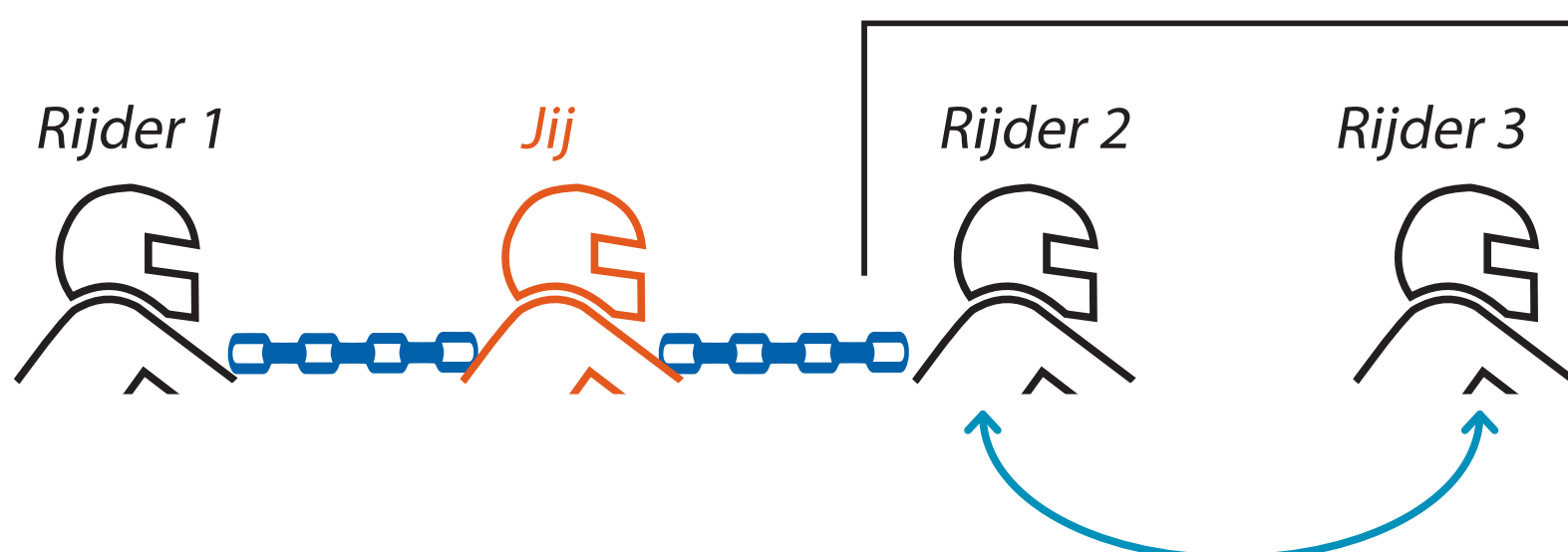

# Intercom



Beginnen / Eindigen / Rijder 1 toevoegen

Rijder 1



x1

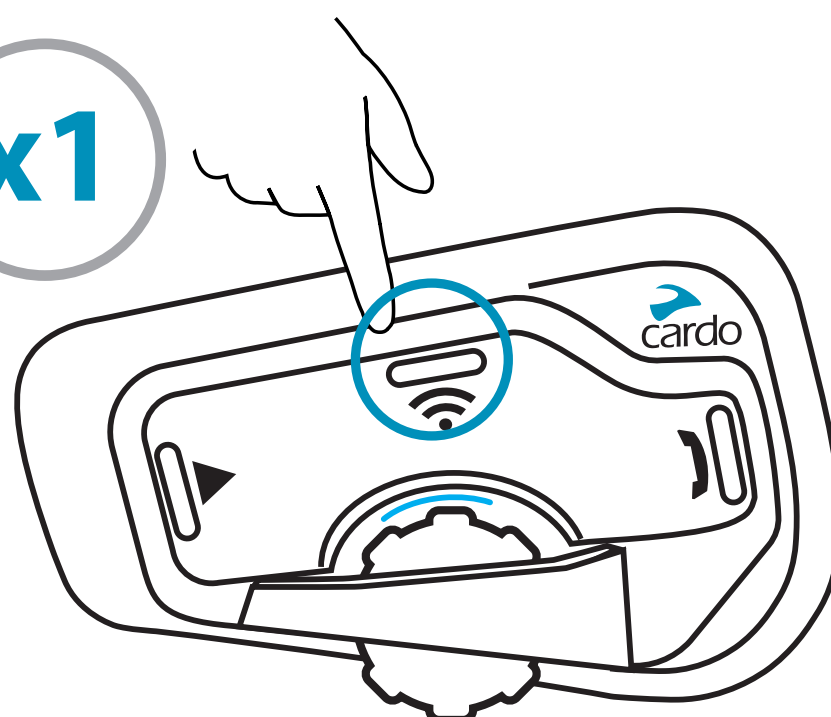

Beginnen / Eindigen / Rijder 2 toevoegen

Rijder 2



x2

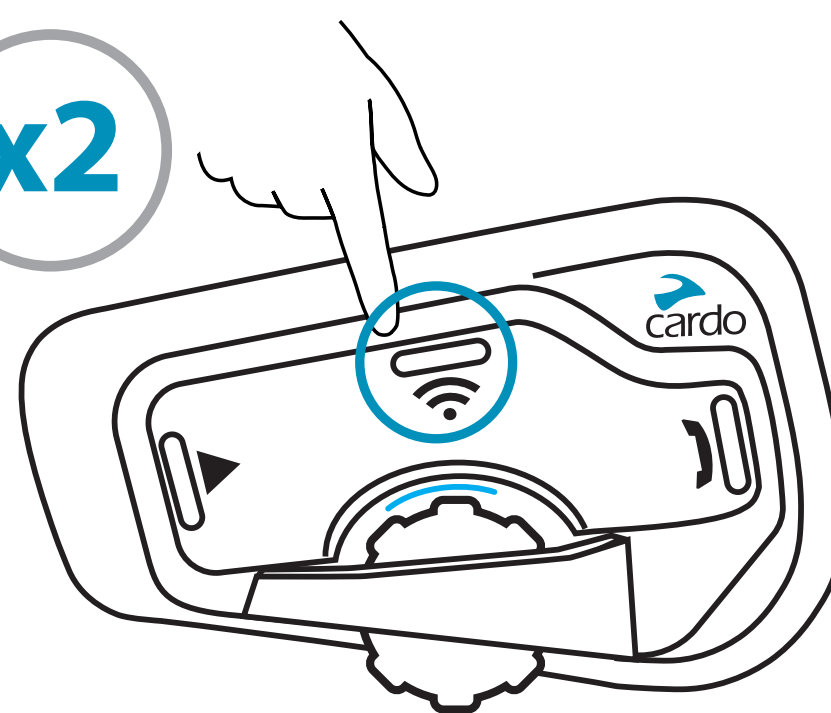

## Initieer 4-weg intercom conferentie

Rijder 1



Jij



Rijder 2



Rijder 3

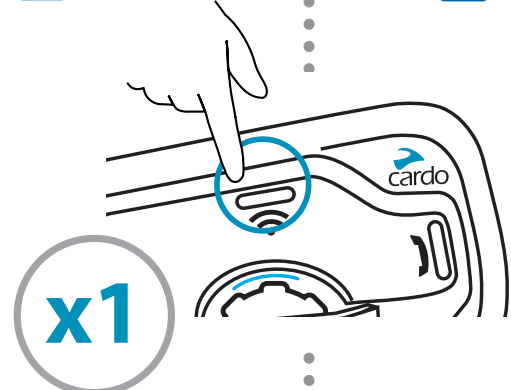

Verbindt met  
rijder 1

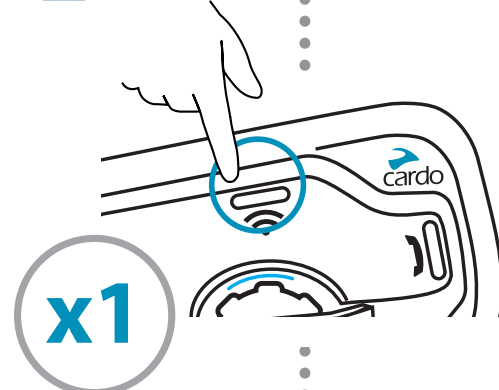

Verbindt met  
rijder 3

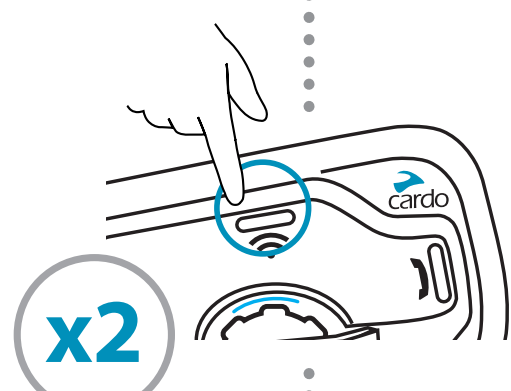

Verbindt met  
rijder 2



# Spraakcommando's Altijd aan!



- "Hey Cardo, **radio on**"
- "Hey Cardo, **radio off**"
- "Hey Cardo, **next station**"
- "Hey Cardo, **previous station**"



- "Hey Cardo, **music on**"
- "Hey Cardo, **music off**"
- "Hey Cardo, **next track**"
- "Hey Cardo, **previous track**"



- "Hey Cardo, **volume up**"
- "Hey Cardo, **volume down**"
- "Hey Cardo, **mute audio**"
- "Hey Cardo, **unmute audio**"



- "Hey Cardo, **speed dial**"
- "Hey Cardo, **redial number**"
- **Answer**
- **Ignore**



- "Hey Siri"
- "Ok Google"



- "Hey Cardo, **battery status**"
- "Hey Cardo, **call intercom**"

# Fabrieksreset

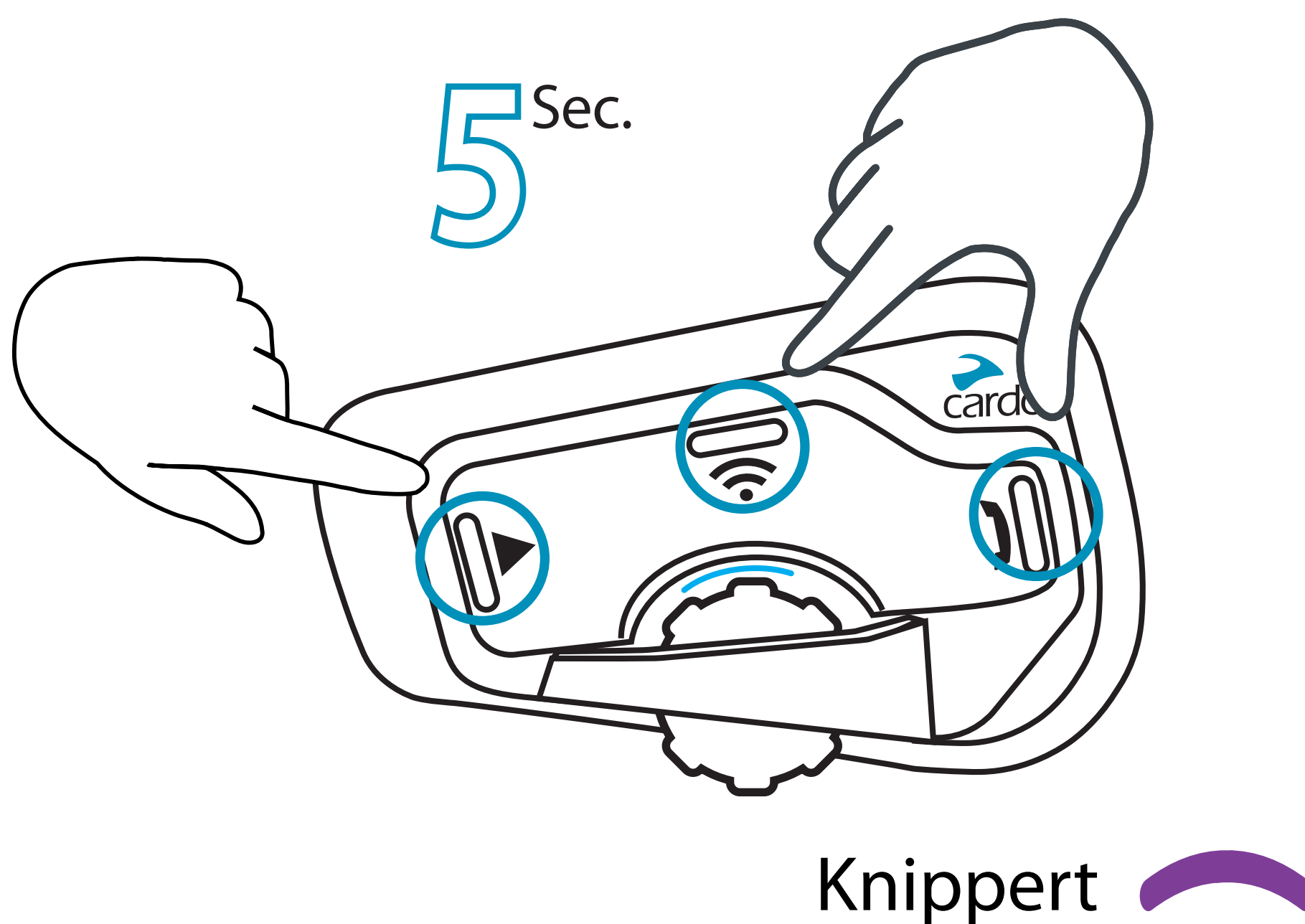

## Cardo Mobiele App

- Eenvoudige configuratie
- Afstandsbediening
- On-the-go instellingen aanpassen

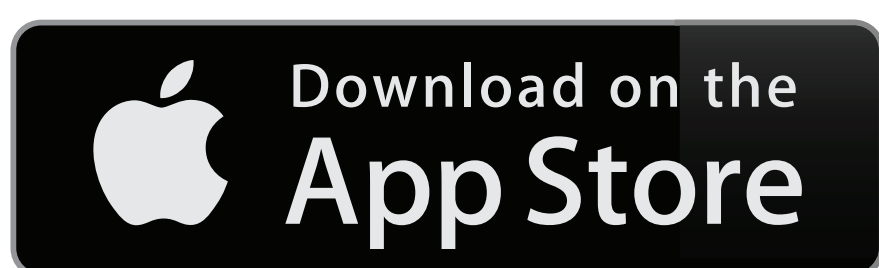

Cardo  
Connect  
App



Volledige versie van de handleiding  
[cardosystems.com/support](http://cardosystems.com/support)

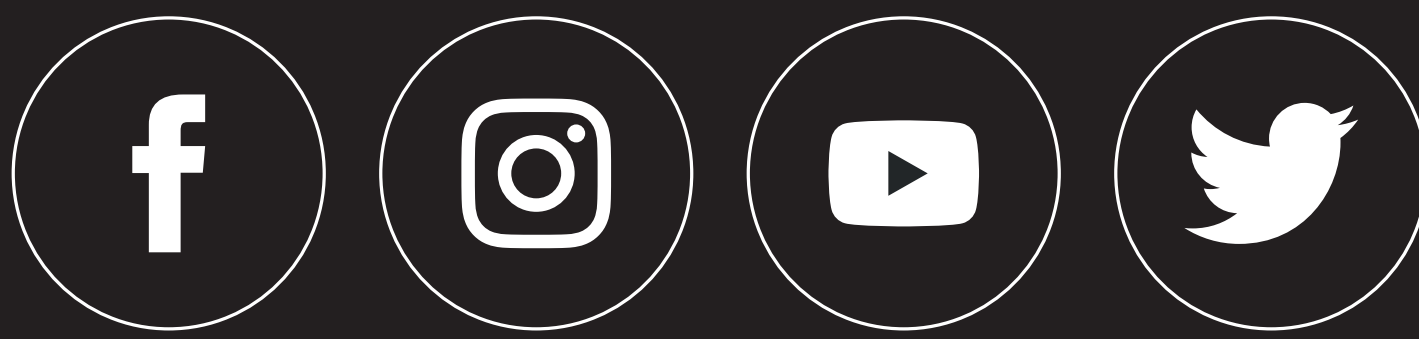

[cardosystems.com](http://cardosystems.com)