



PACKTALK BLACK

NL SNELSTARTGIDS



OPERATED BY
NATURAL VOICE



DYNAMIC
MESH
COMMUNICATION

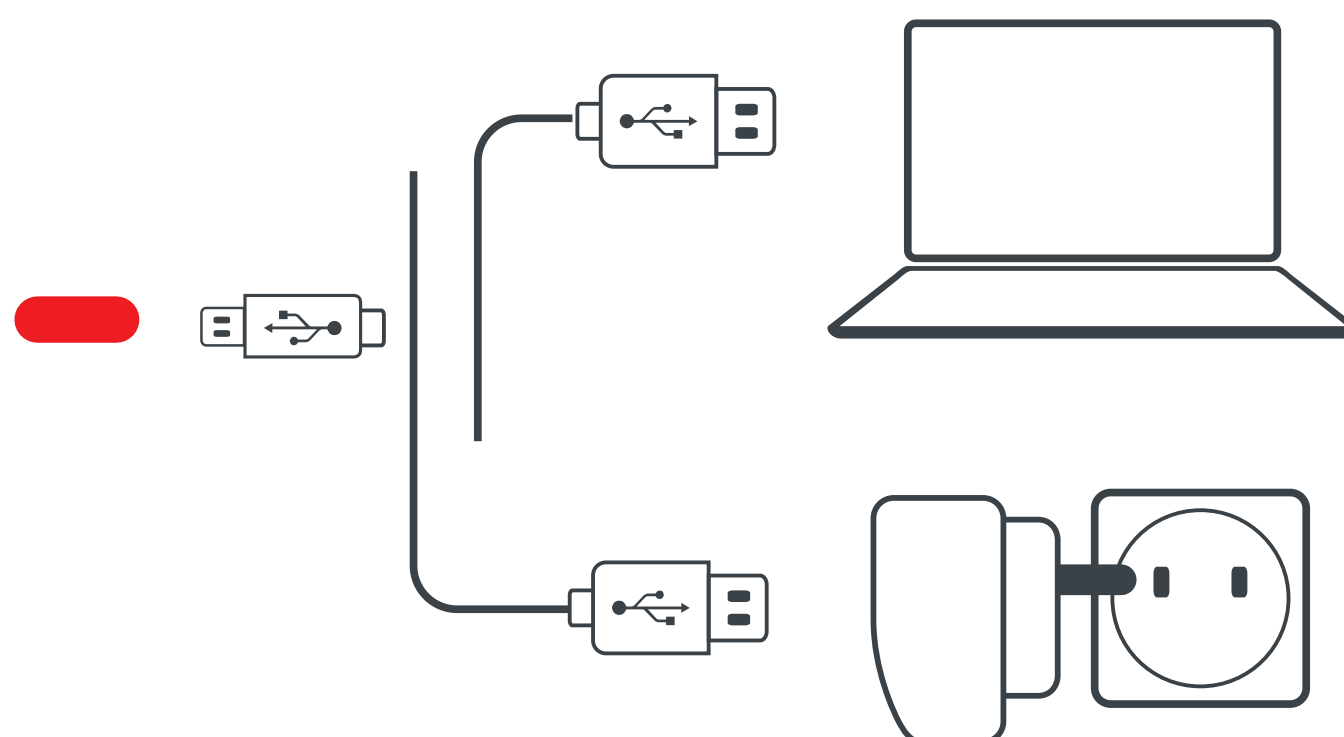
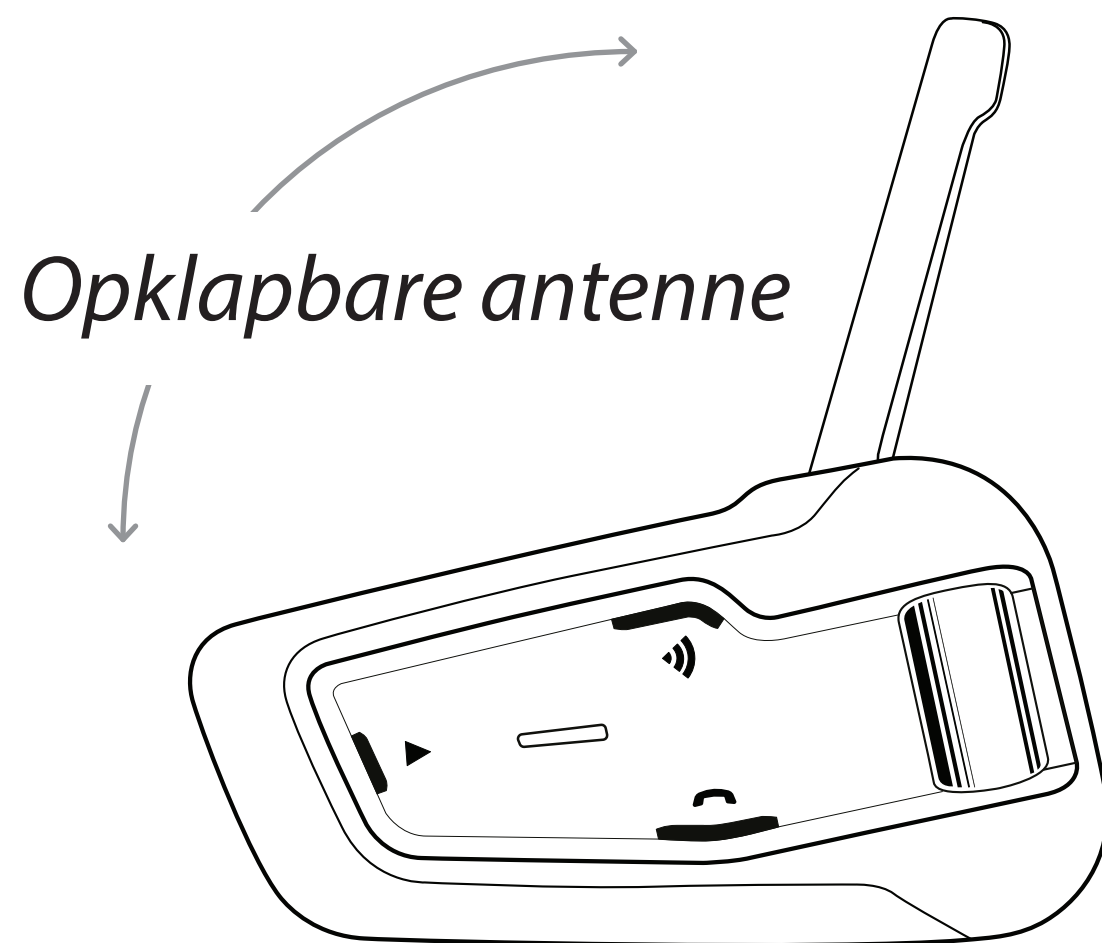
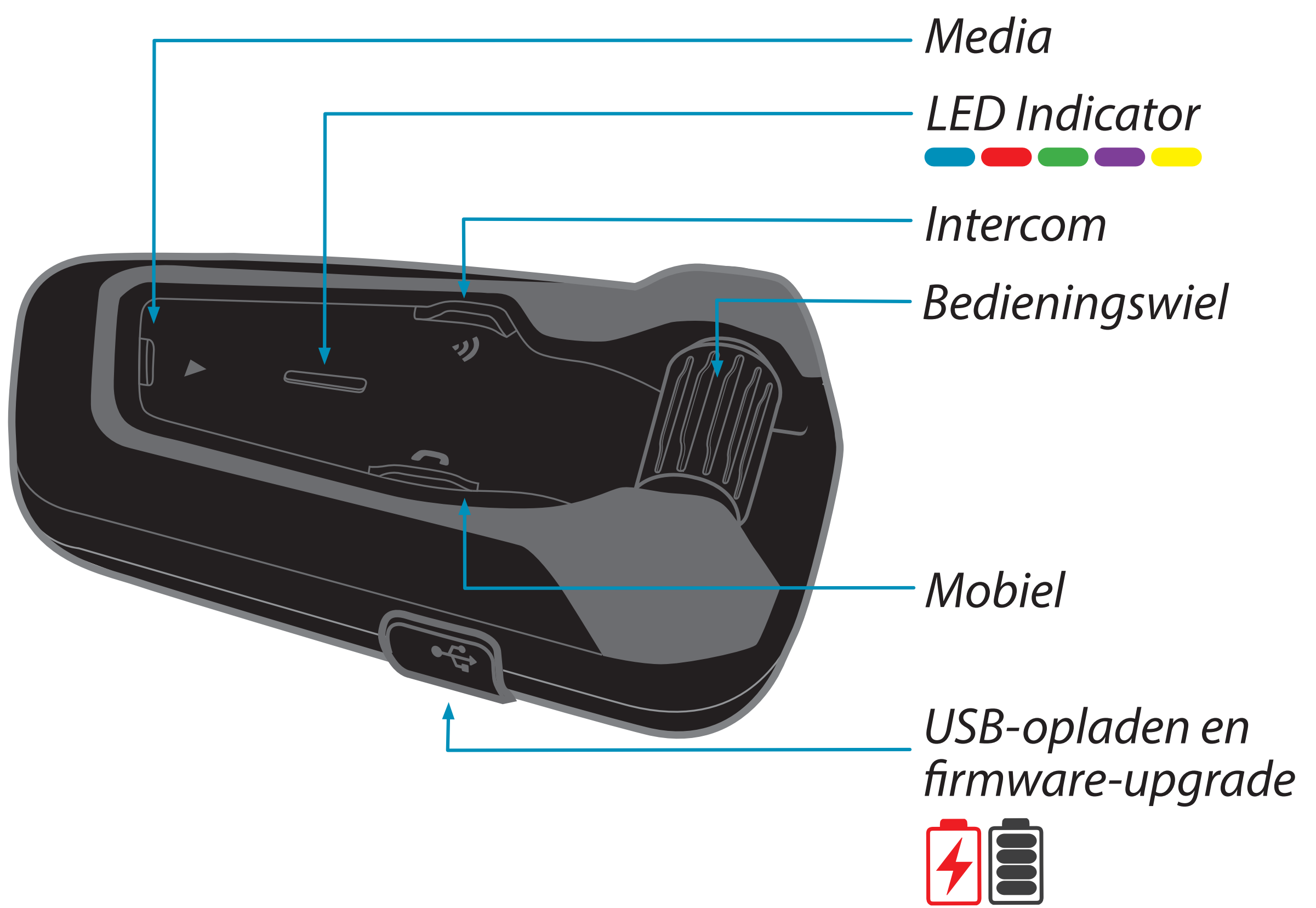

De standaardtaal is Engels.
Taal kan worden gewijzigd via de Cardo Connect-app

Aan De Slag



Aan / Uit

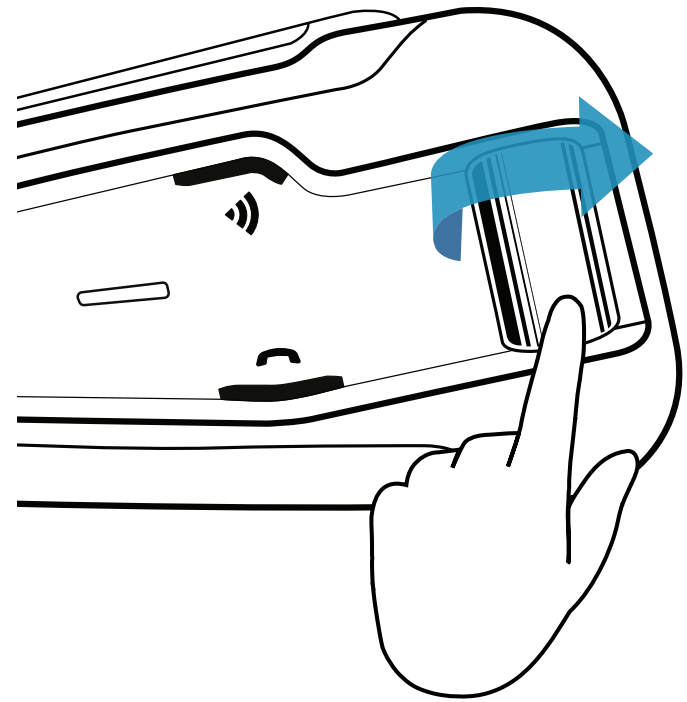
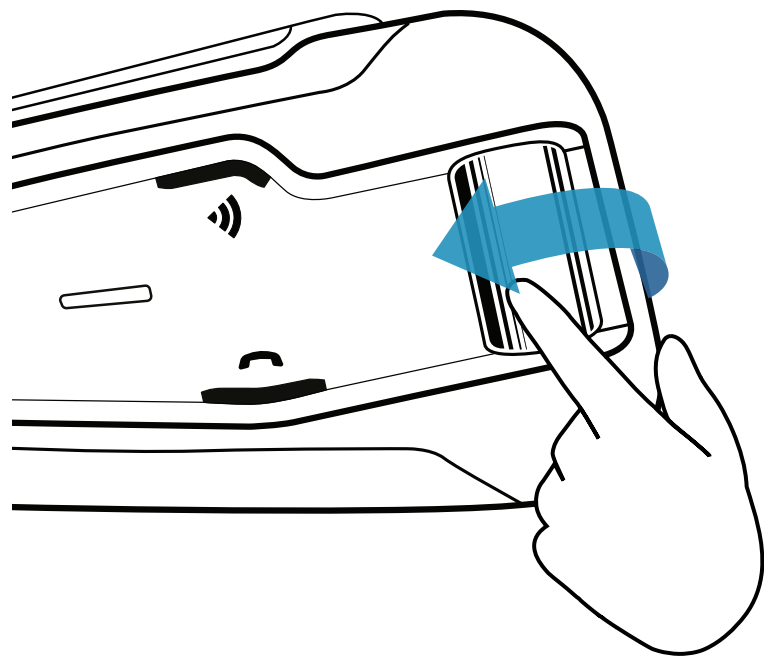
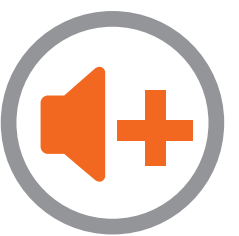
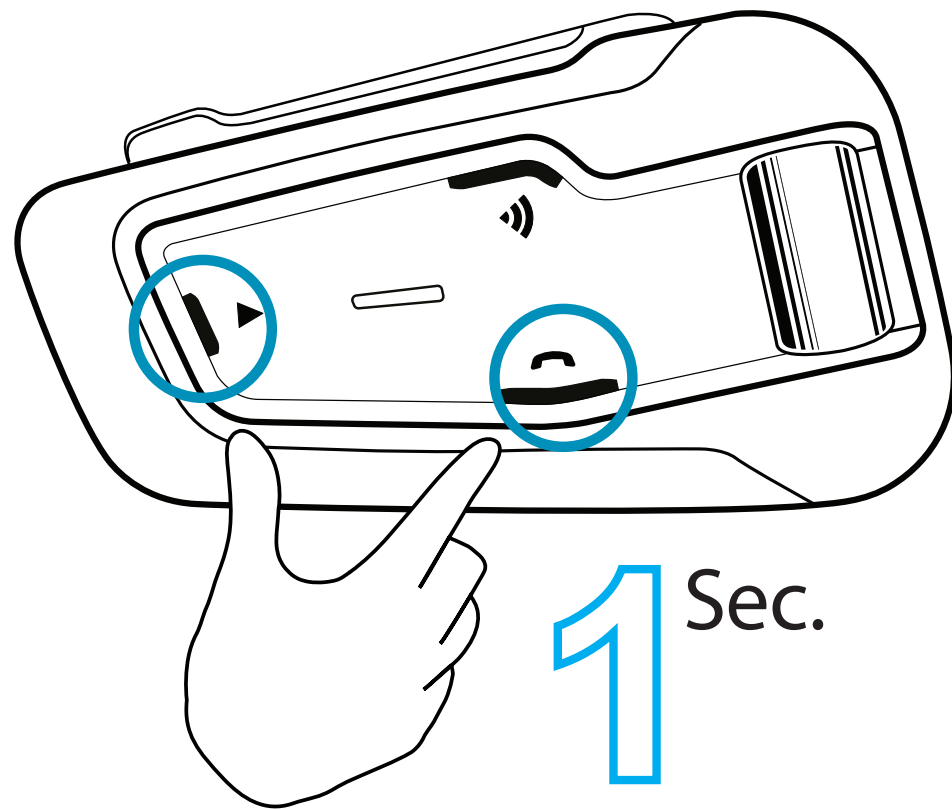

Mute / Unmute

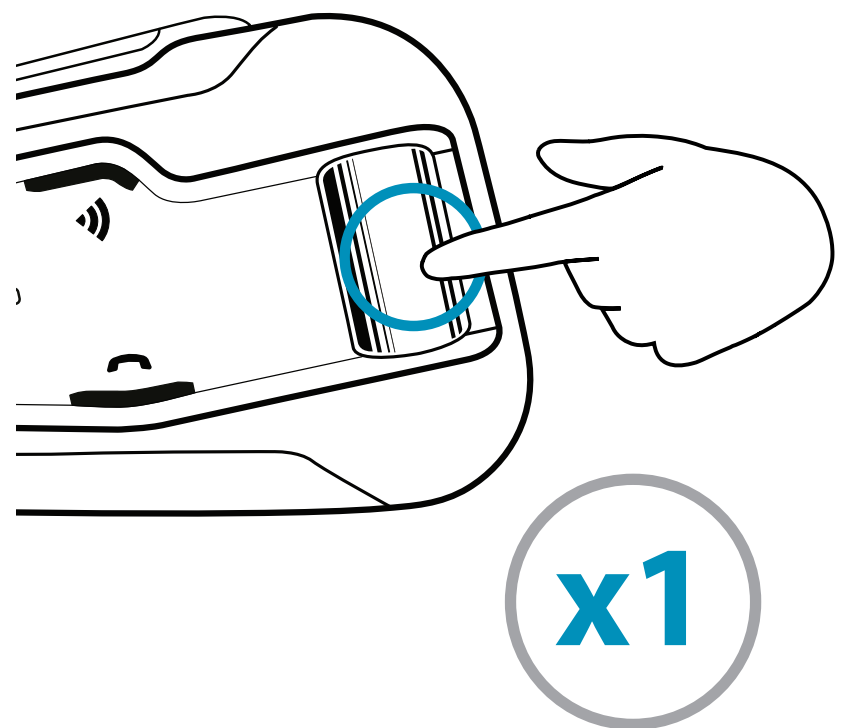
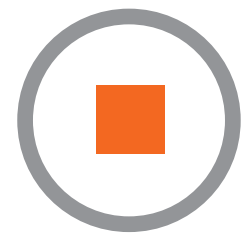
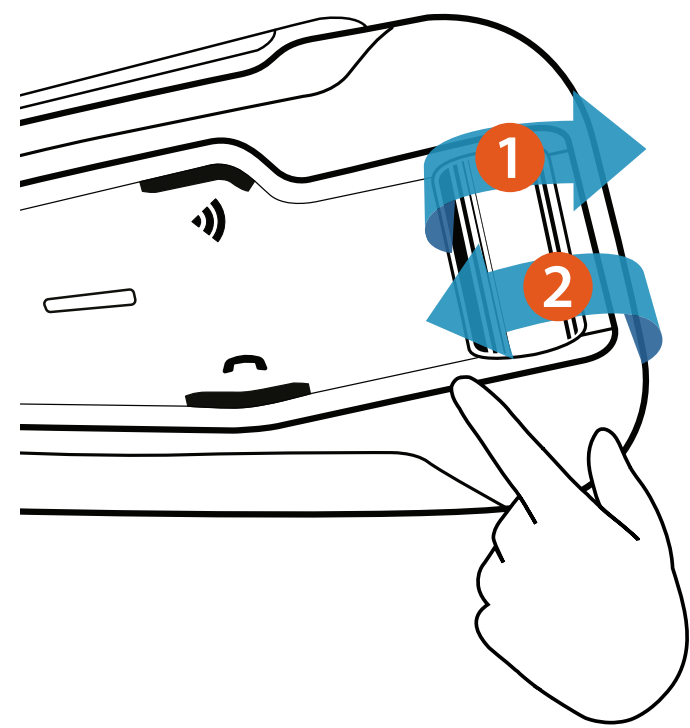

Gebruik tijdens opladen

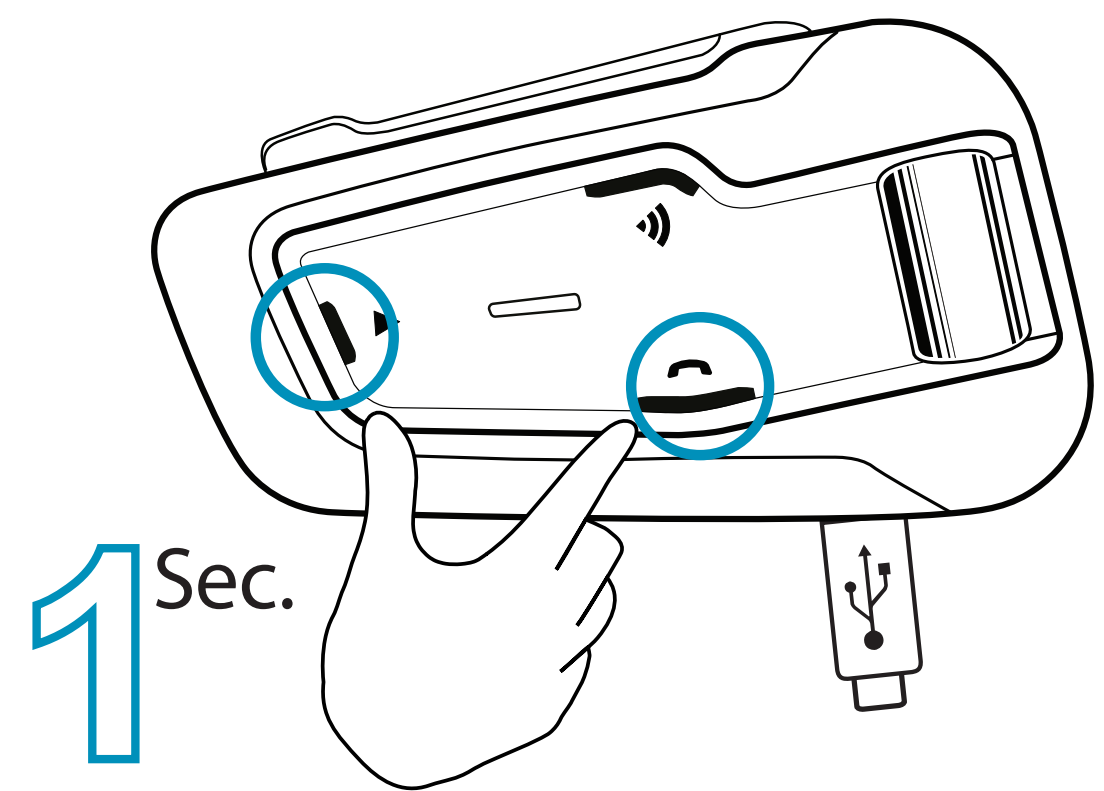
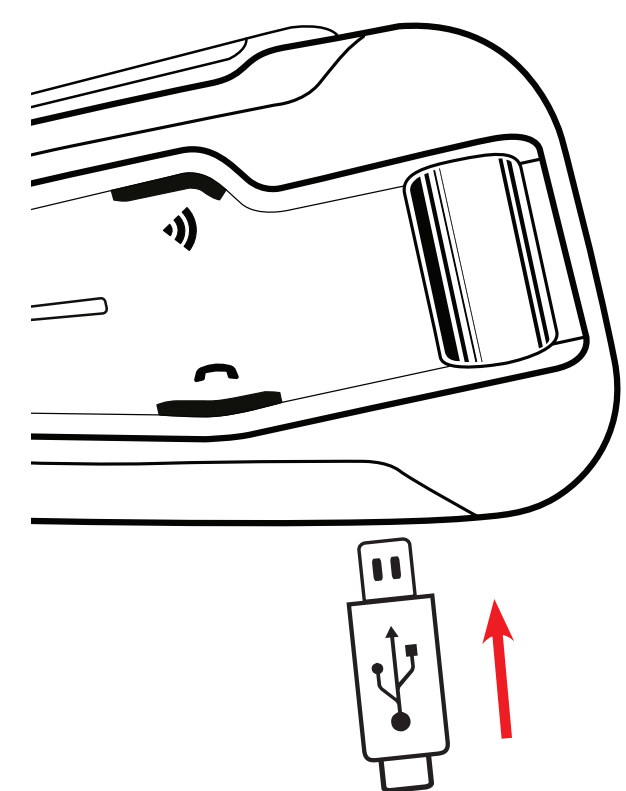

Mobiele apparaten koppelen

1 Initieer

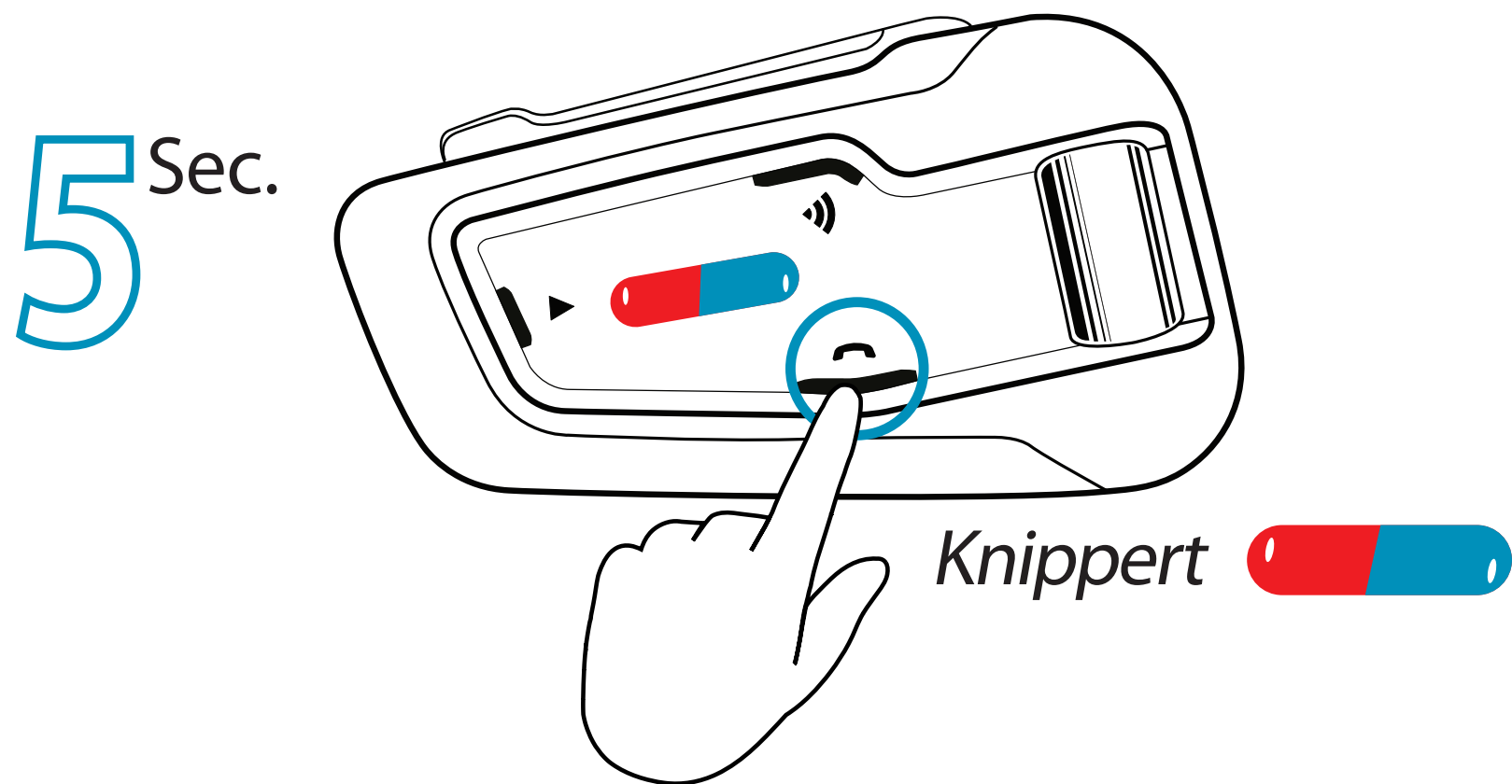

2 Telefoon koppelen

Zoeken naar
Bluetooth-
apparaten

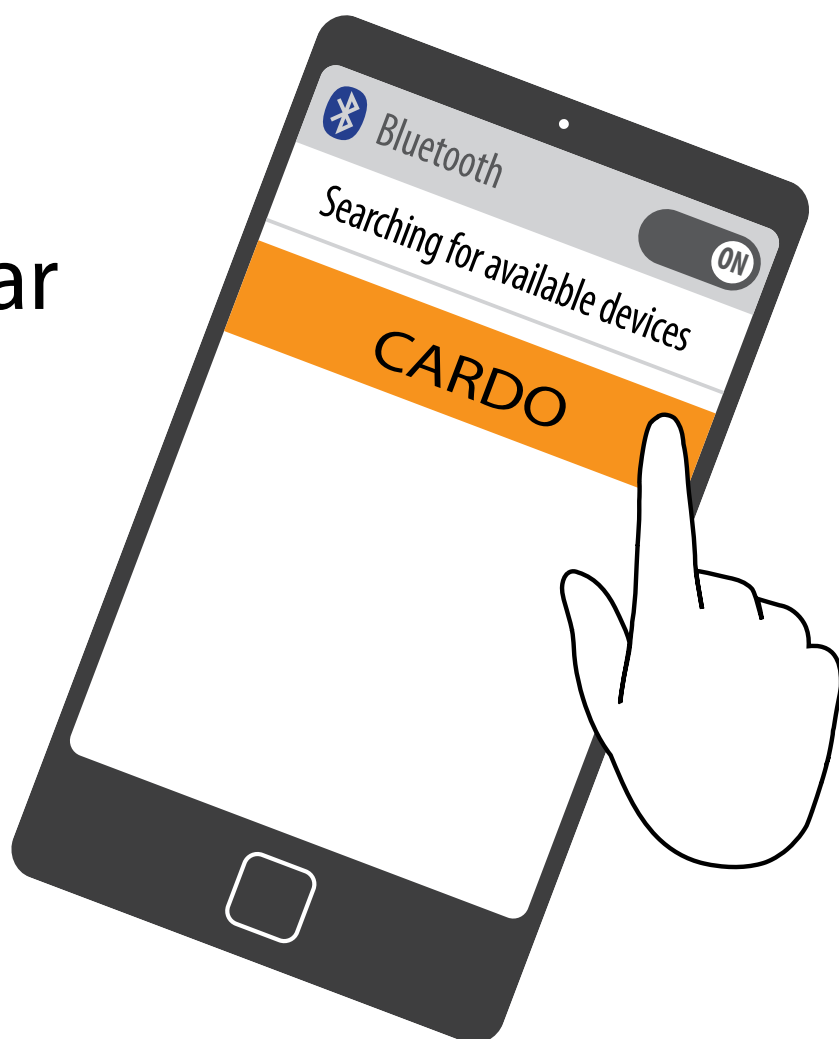

Annuleer het koppelen

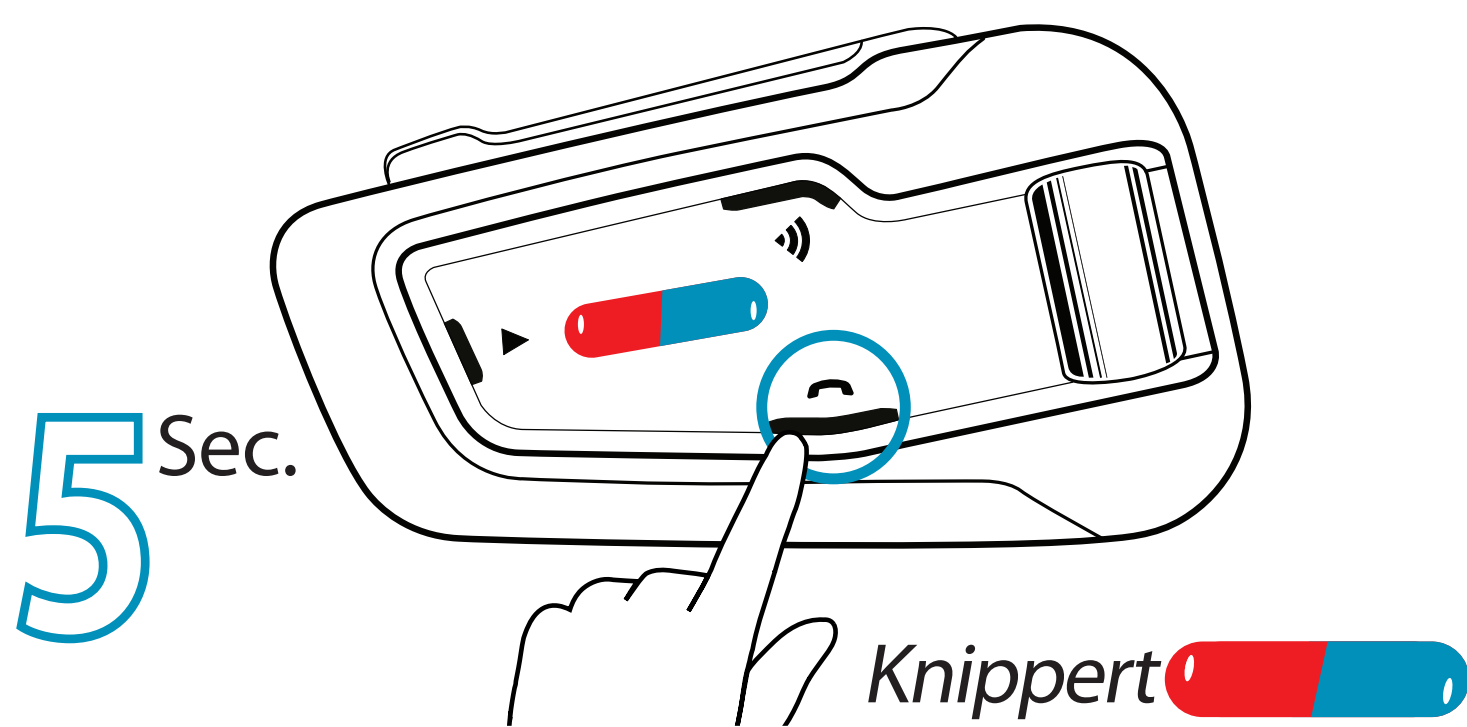

END

Succesvol

Knippert



Mobiele apparaten koppelen

1 Initieer

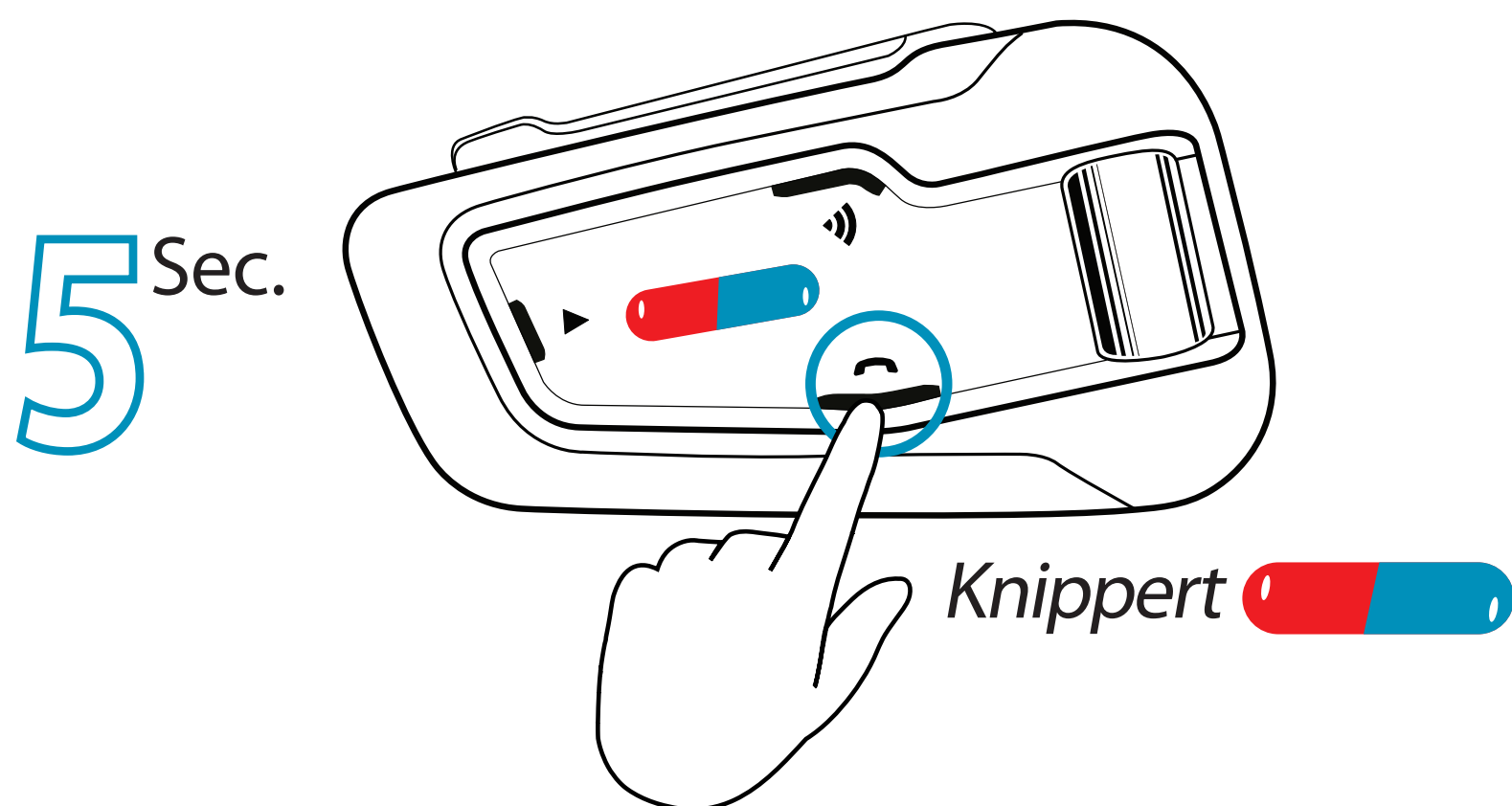

2 Een 2e telefoon / GPS toevoegen

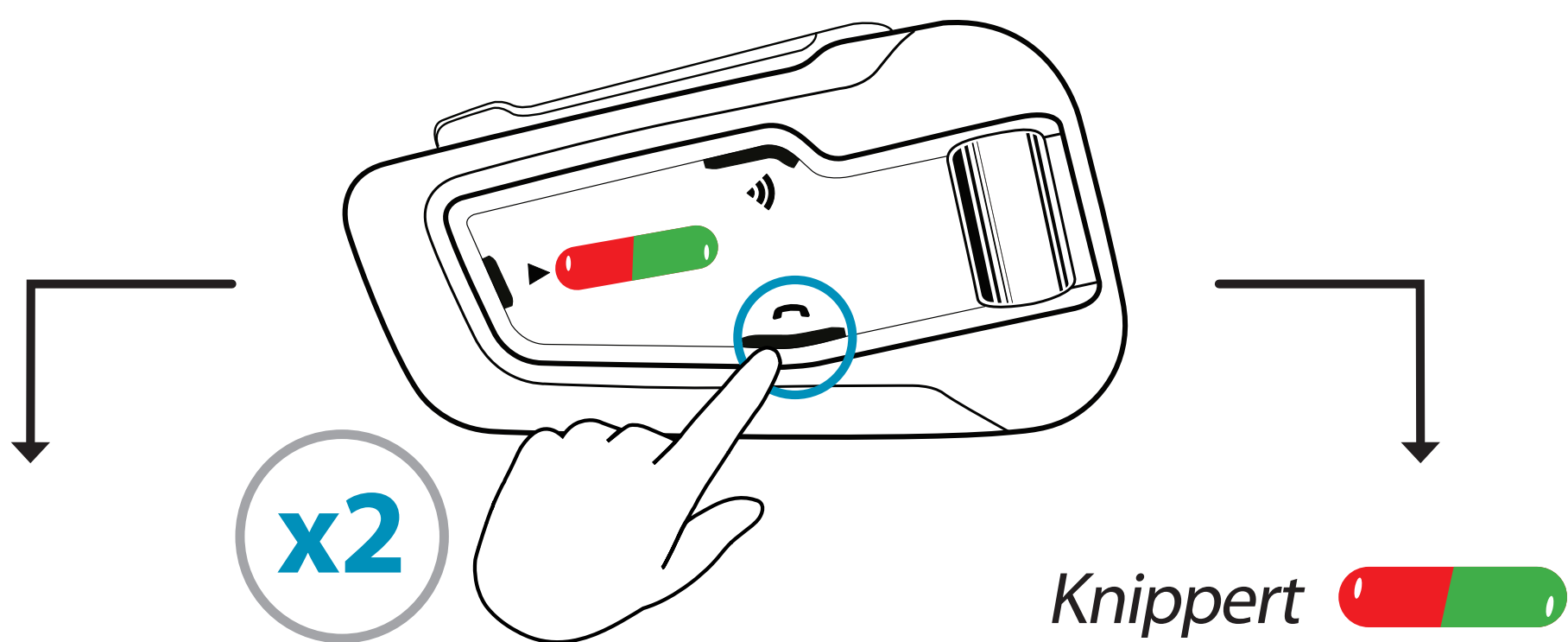

3 Telefoon koppelen

Zoeken naar Bluetooth-apparaten



3 Koppelen GPS

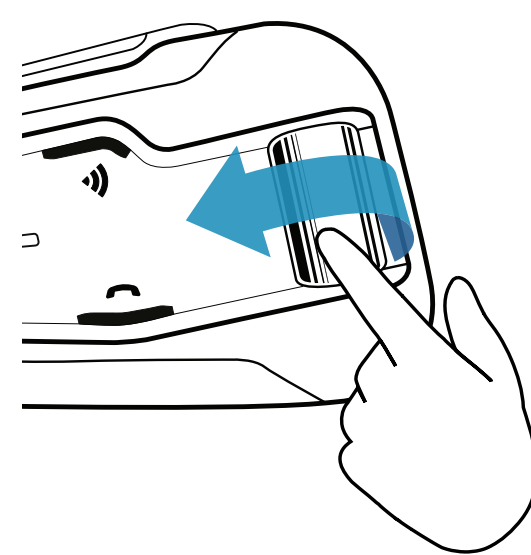

3a

Bluetooth-apparaten zoeken op de GPS



END

Succesvol

Knippert



Telefoon



Nummer kiezen

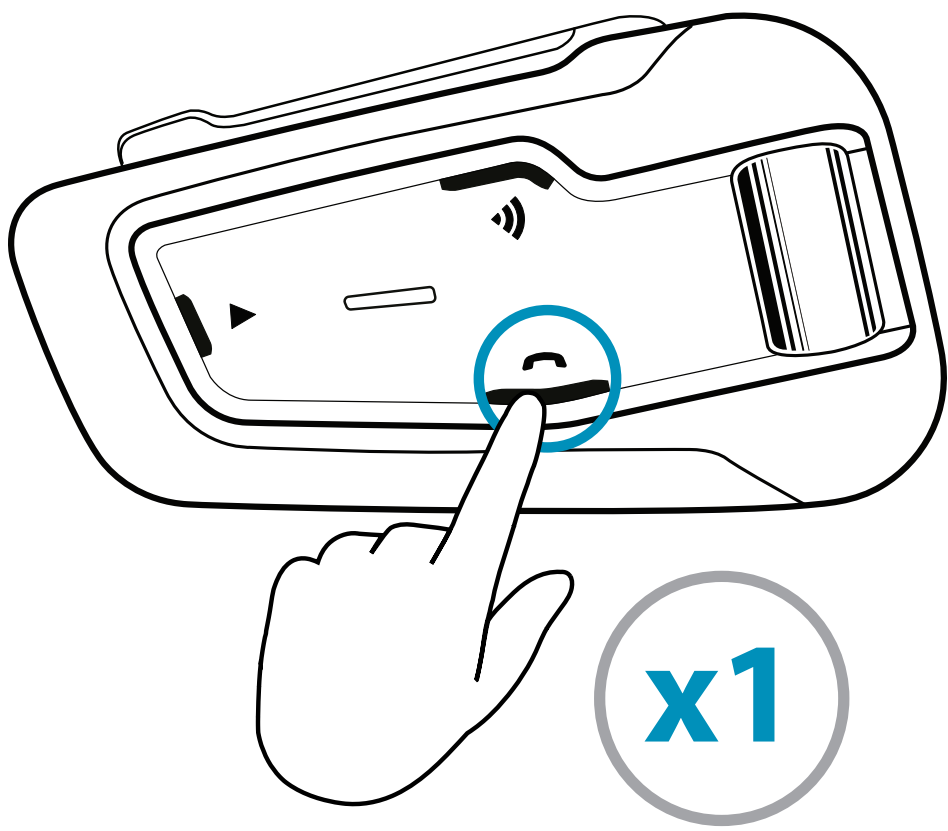

Nummerherhaling

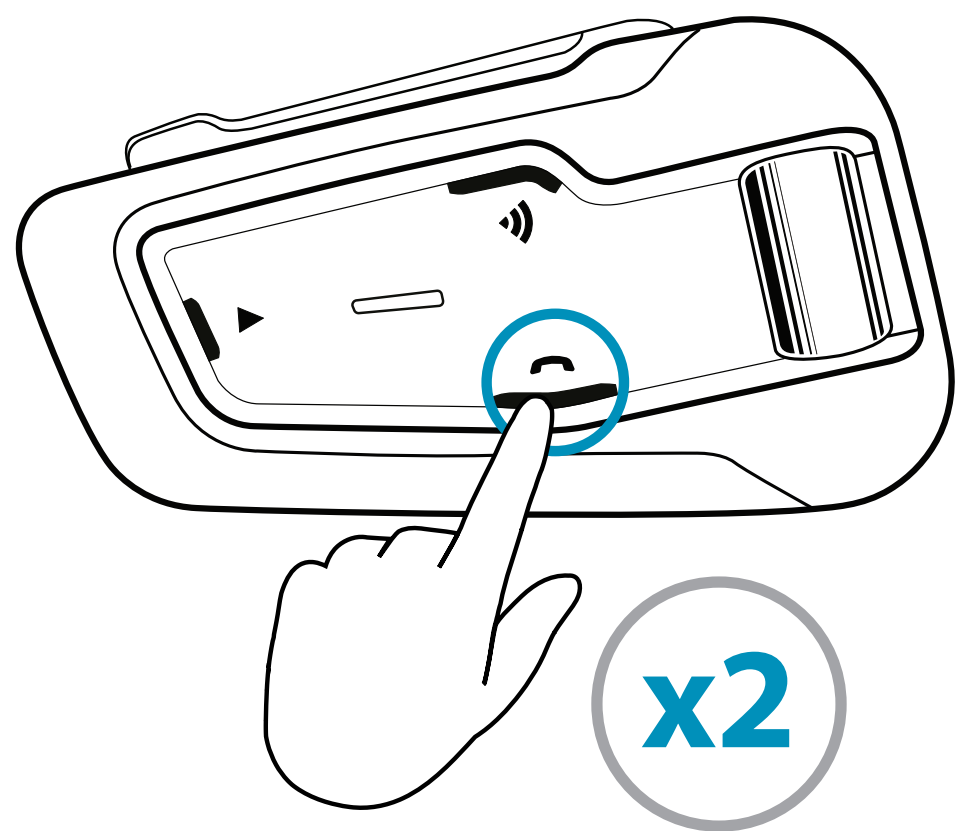

Snelkiezen

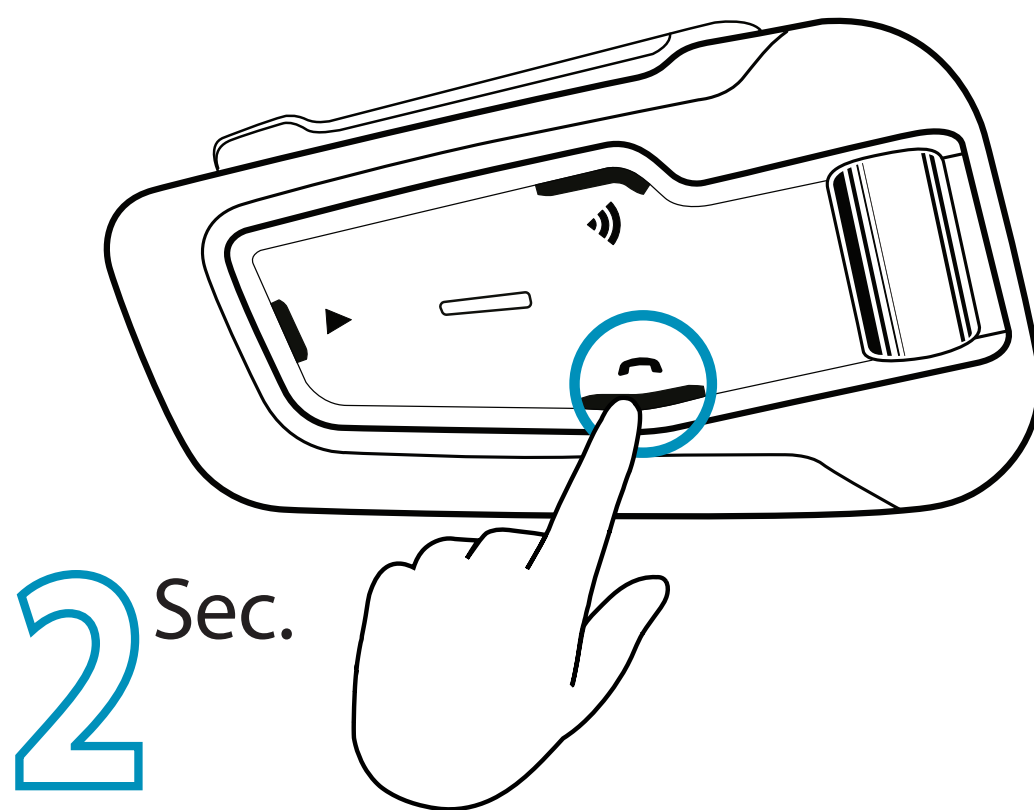

Ingesteld via app

Gesprek delen met DMC-groep

Overbruggen van actieve telefoongesprekken naar de DMC-groep

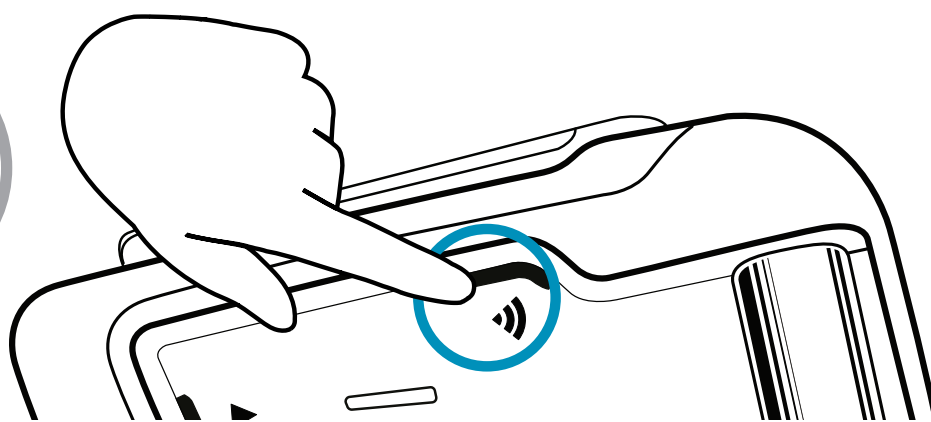

Delen gesprek starten/stoppen

Telefoon



Beantwoord een oproep

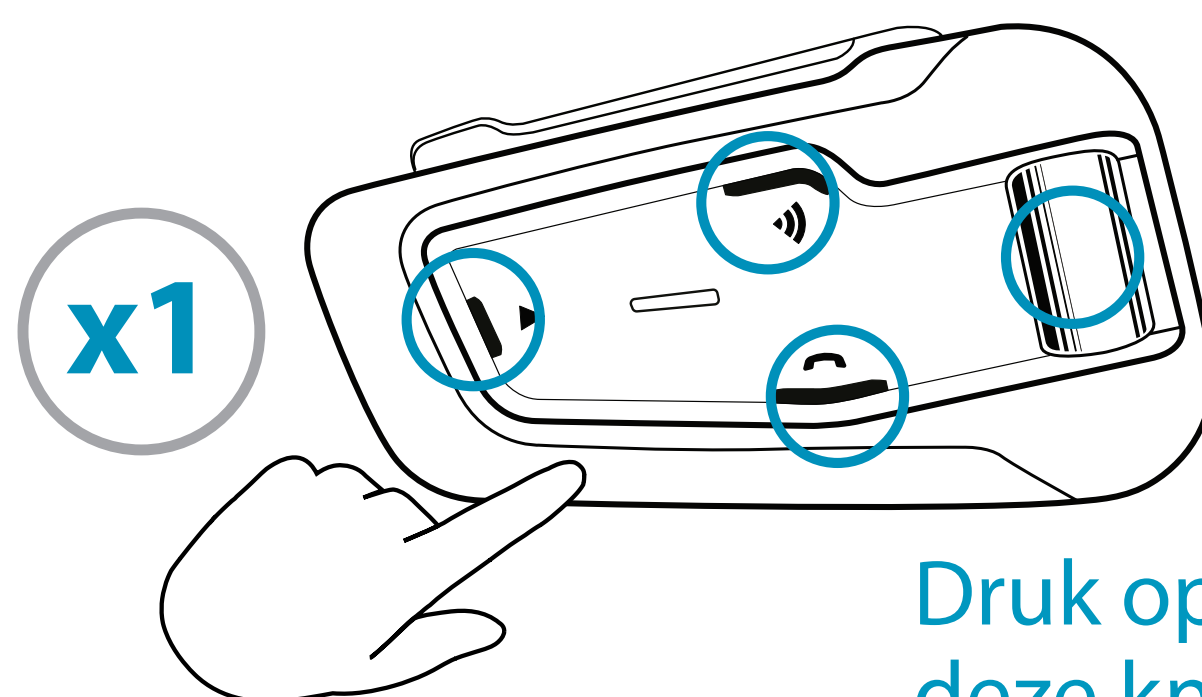

Druk op een van deze knoppen



Een oproep negeren

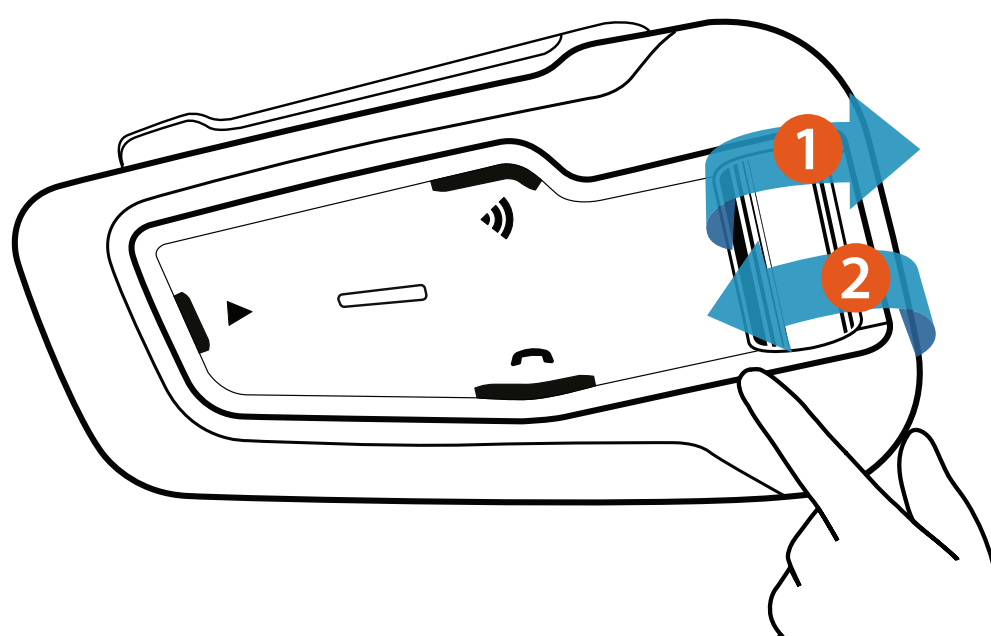

Een oproep weigeren

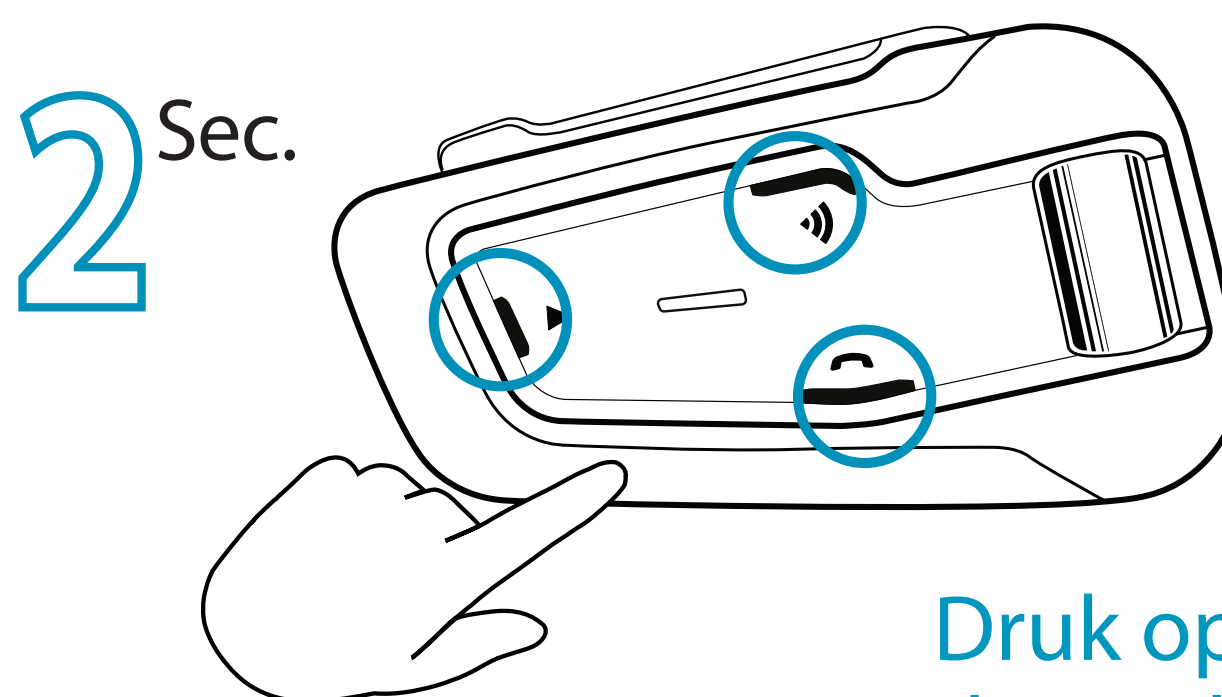

Druk op een van deze 3 knoppen



Een gesprek beëindigen

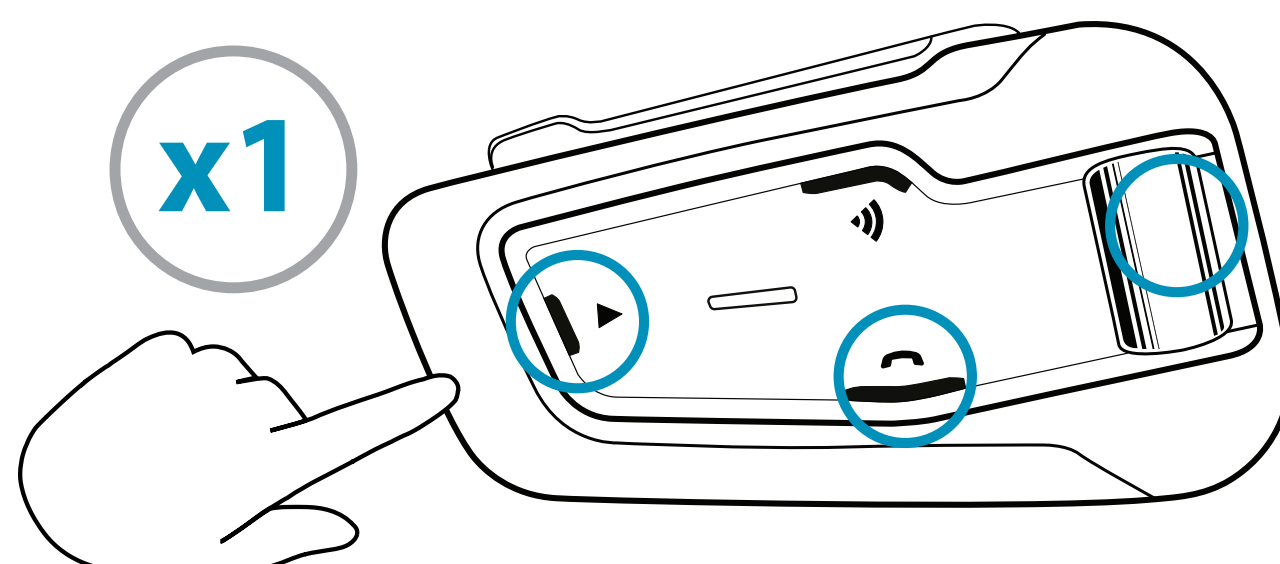

Druk op een van deze 3 knoppen

Audio

FM Radio



Aan

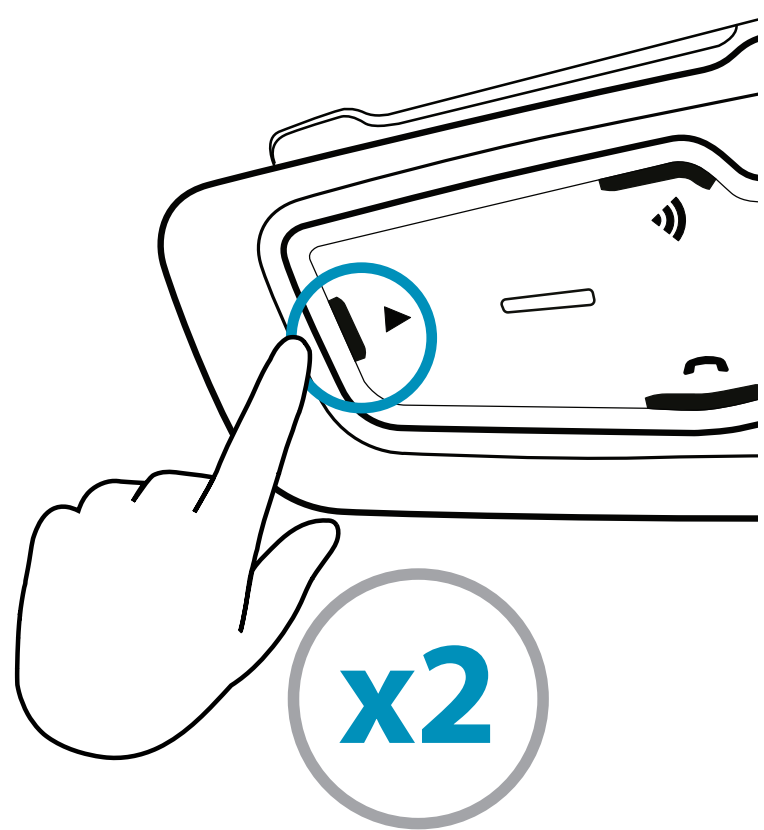

Uit

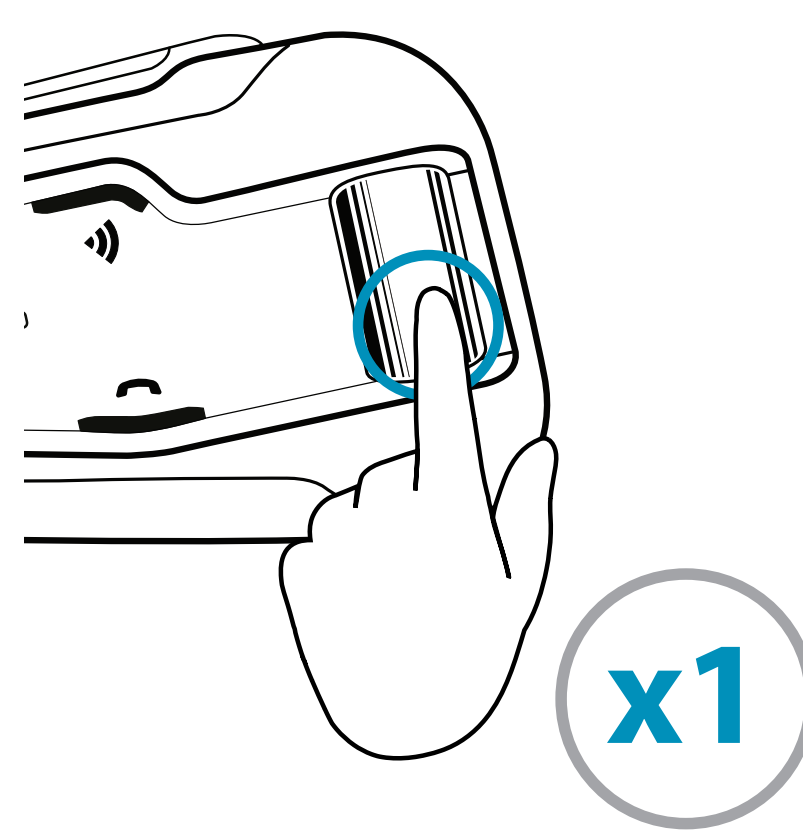

Vorige

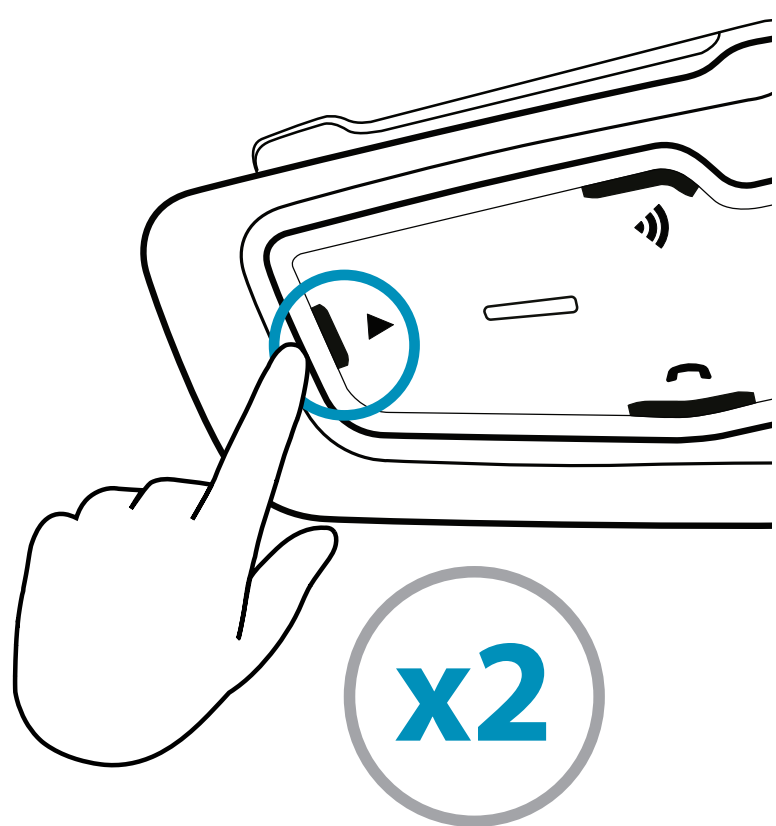

Volgende

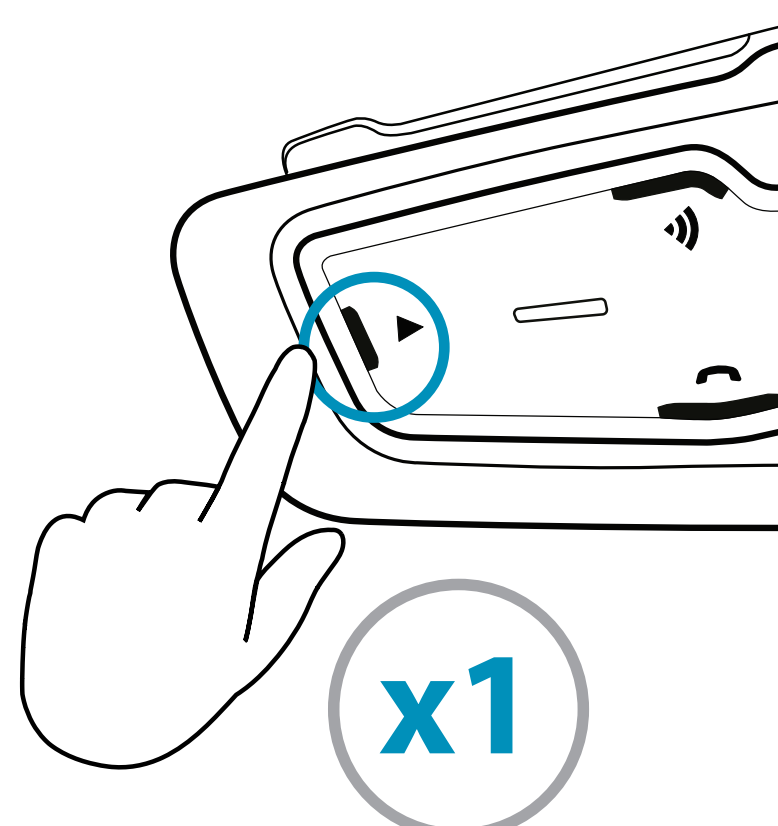

Auto Scan

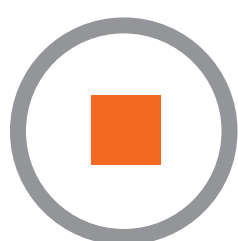

Stop Scan

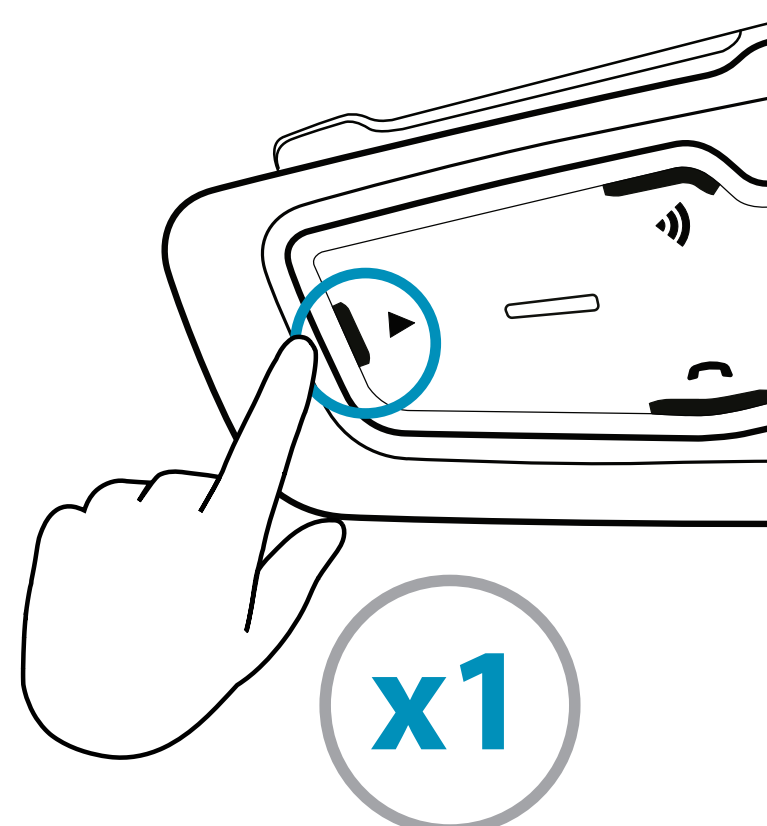

Audio

Muziek



Aan



Uit

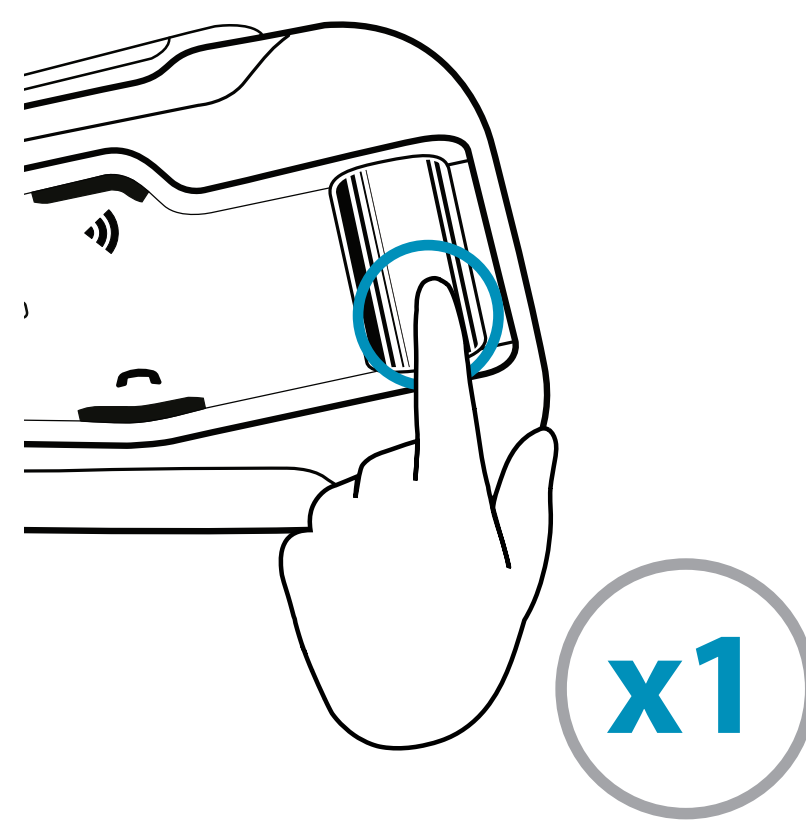
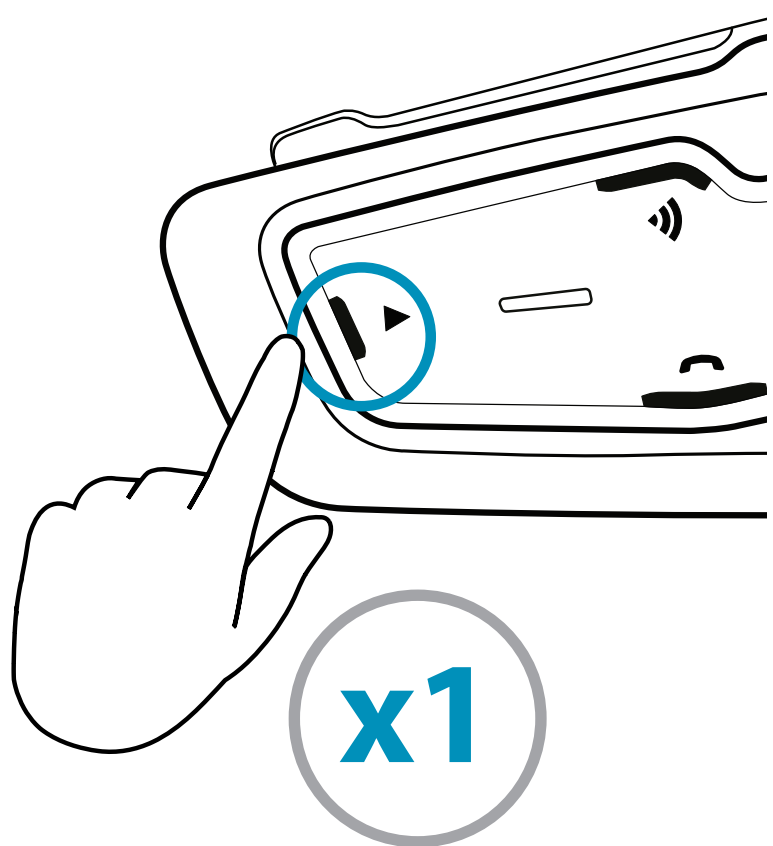

Vorige



Volgende

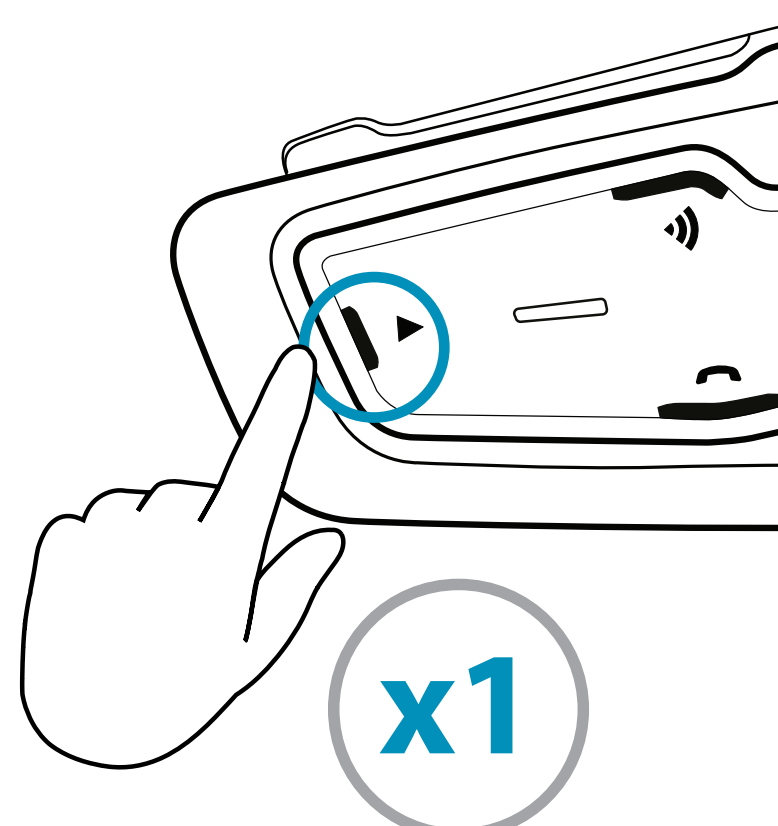
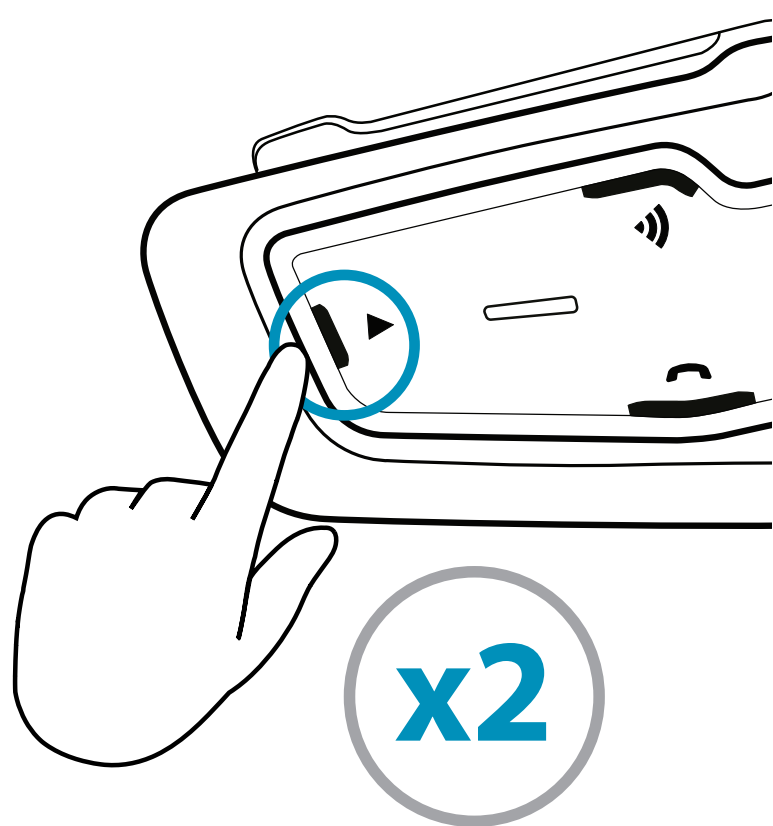

FM/Muziektoets

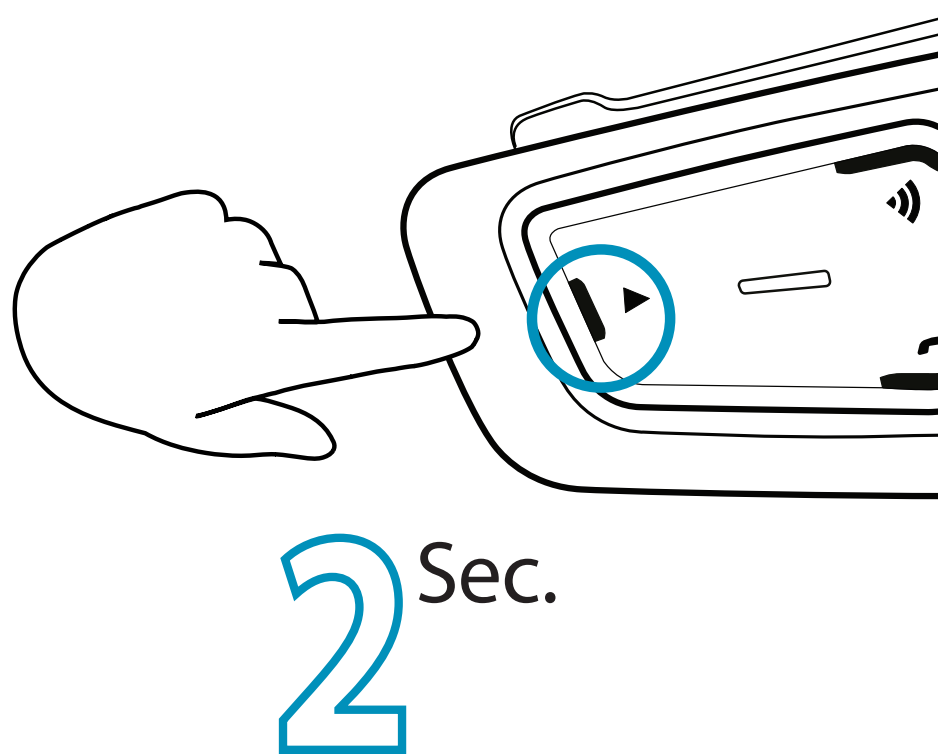

Audio delen

(In Bluetooth-modus)
Zie **bladzijde hiernaast**

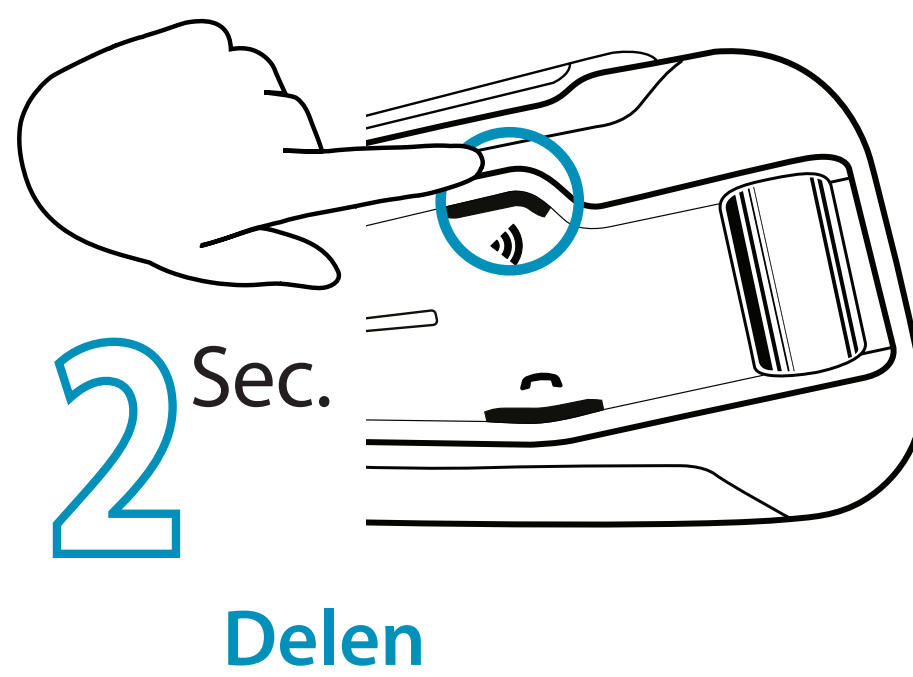

DMC Intercom Grouping

Controleer of je in  DMC modus

Knippert 

 **Bluetooth / DMC**
Intercom-modus wijzigen

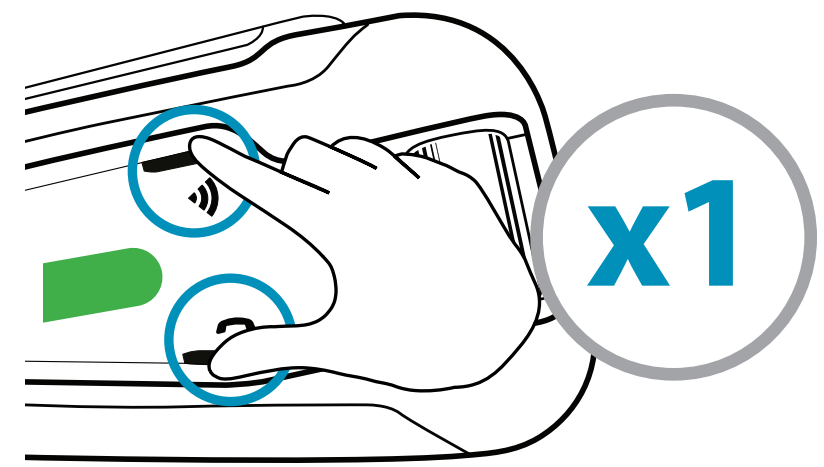

Creëren / Bijtreden nieuwe DMC-groep

1 Admin + alle groepsleden / nieuw lid

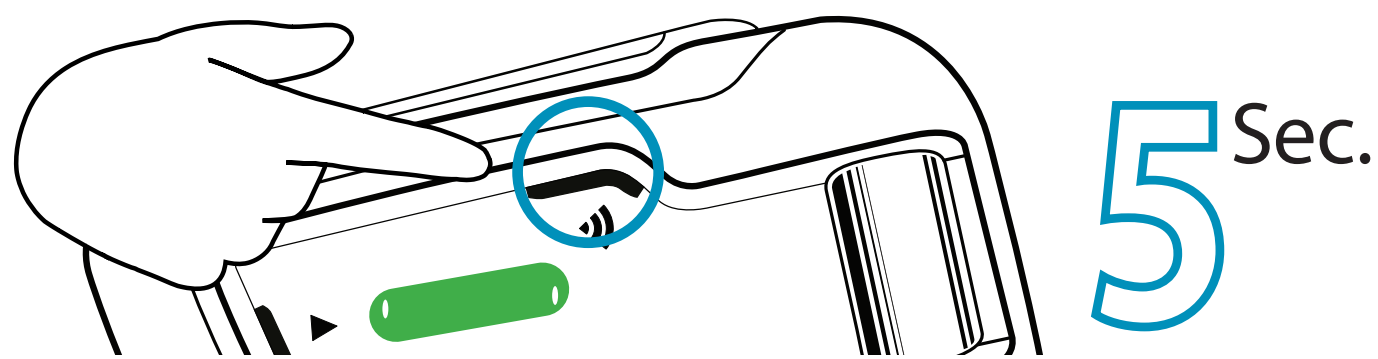

Snel Knippert 

2 **DAN ALLEEN ÉÉN GROEPSADMIN**

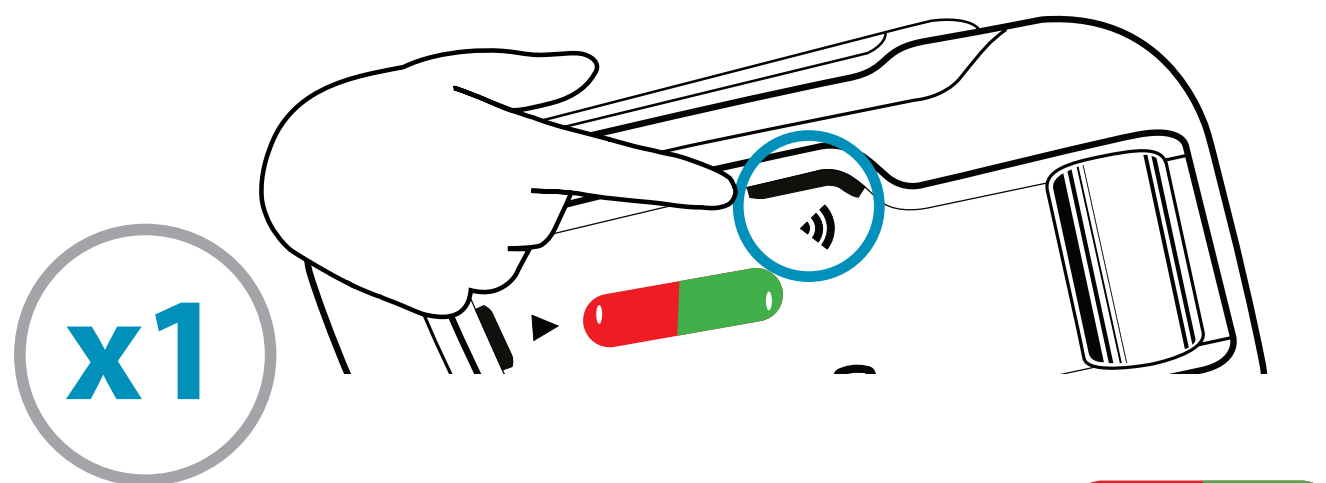

Knippert 

Succesvol gegroepeerd Knippert 

Groepering annuleren

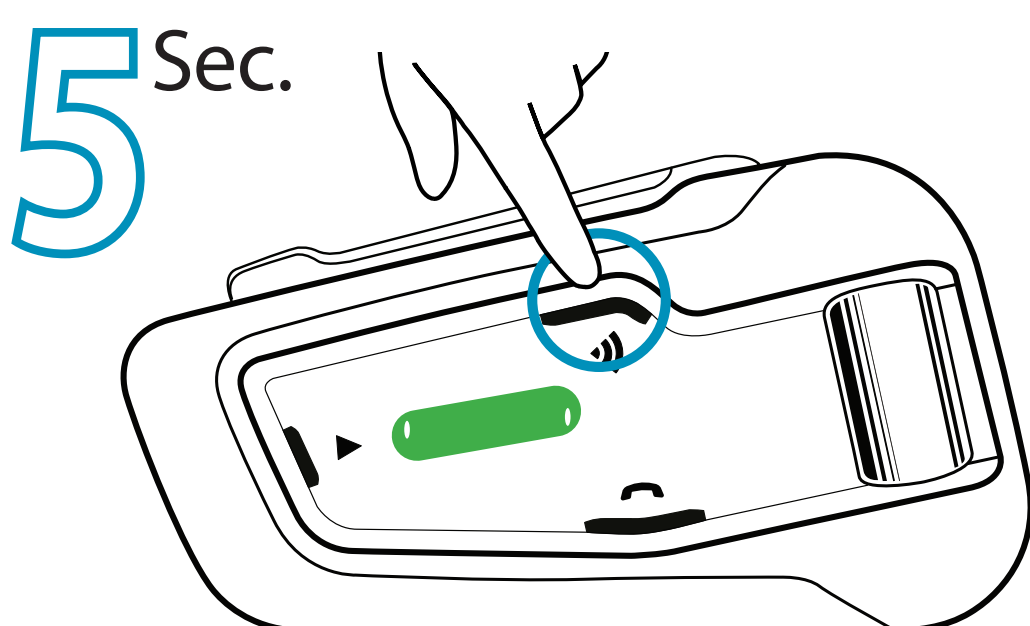

Snel Knippert 

DMC Intercom Groepering

Praten - altijd aan



Groep mute



Groep unmute

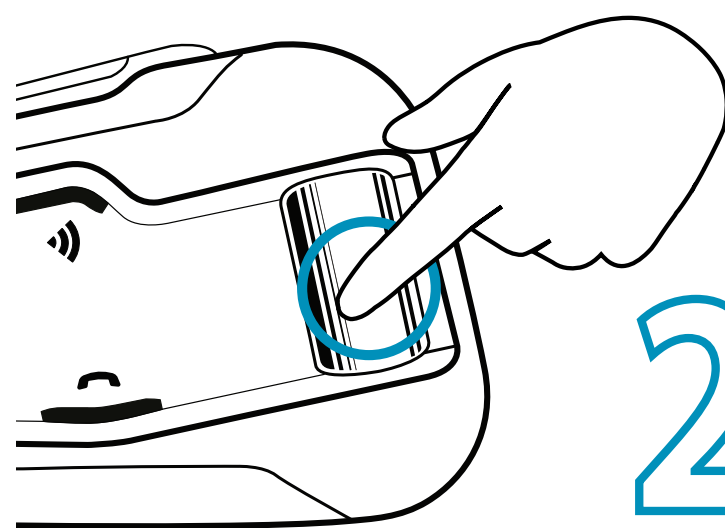

2^{Sec.}

Privé-chat

Chat privé met een van de groepsleden

- 1 Kies lid voor privé-chat via mobiele app

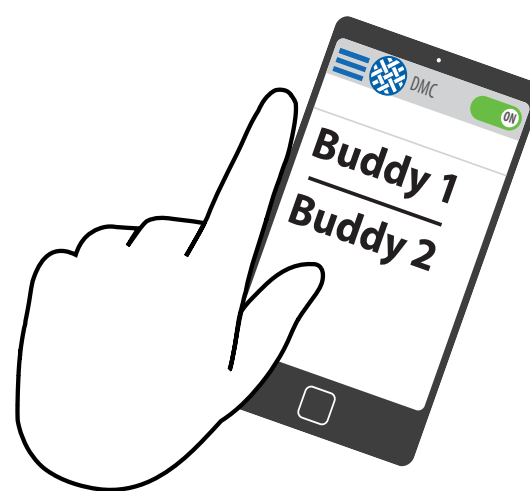

- 2 Chat starten/stoppen

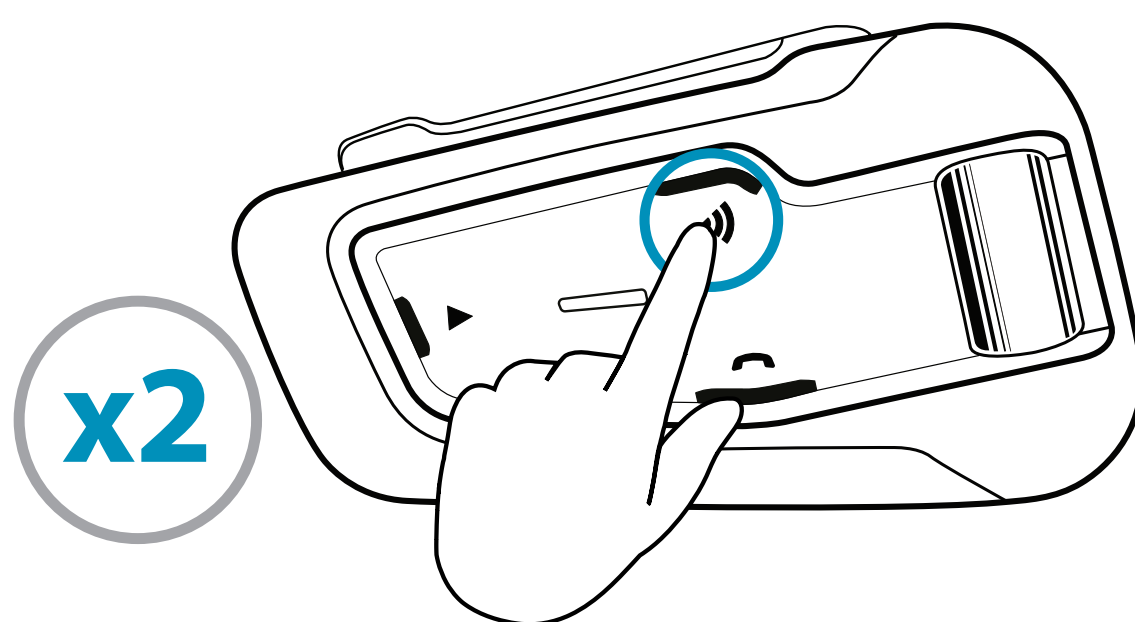

Een niet-DMC passagier overbruggen (toevoegen)

- 1 Controleer **eerst** of de passagier via Bluetooth is gekoppeld. (zie 2-weg Bluetooth-intercomkoppeling)

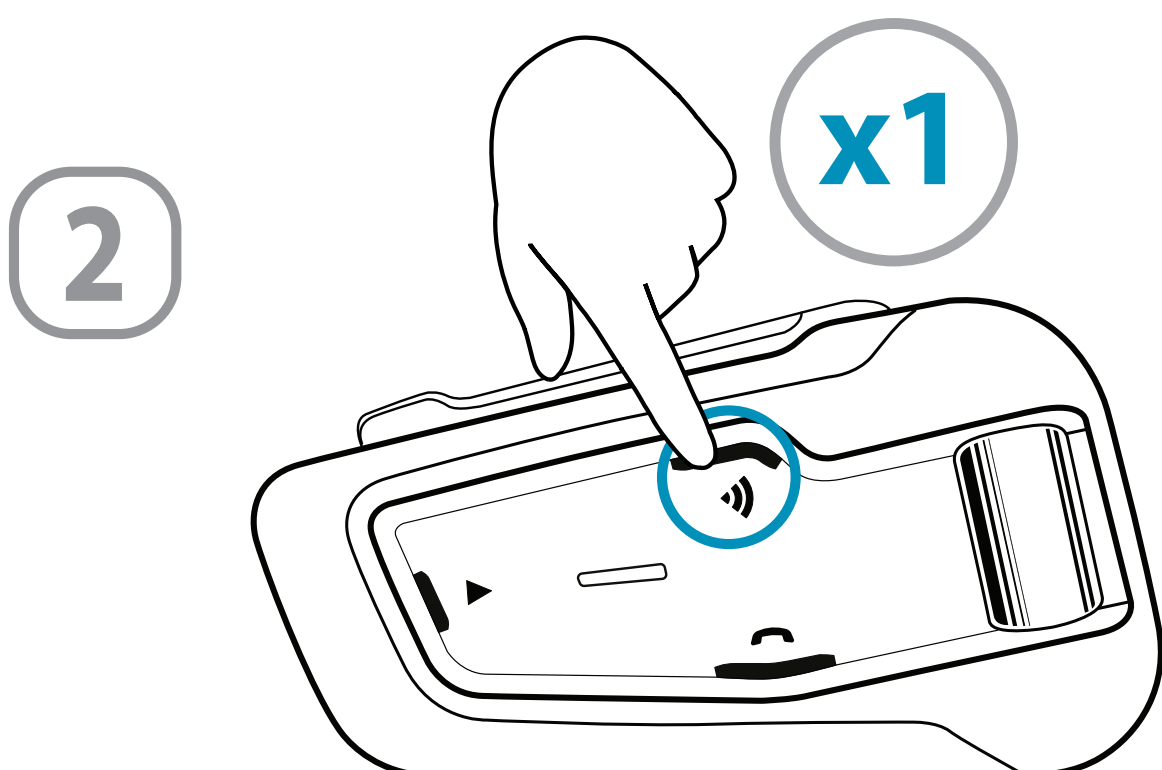

Overbrugging starten/stoppen

Stel een Cardo niet-DMC intercom in

Controleer of je in  Bluetooth Modus

Knippert 

 Bluetooth / DMC Intercom-modus

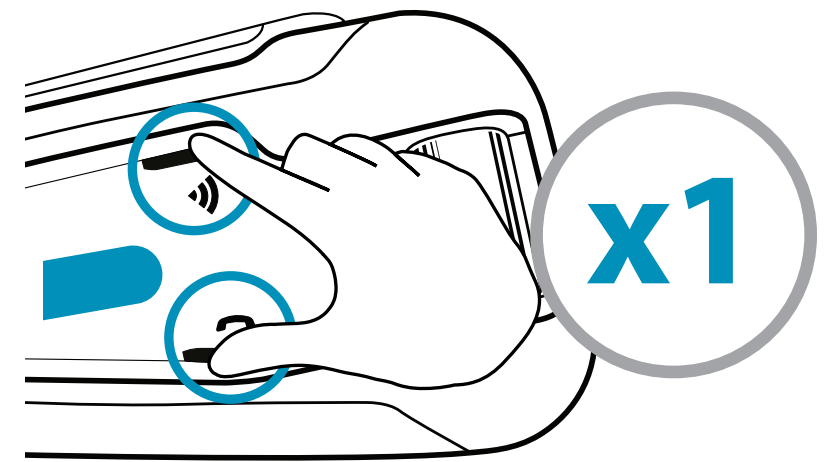

2-weg koppeling

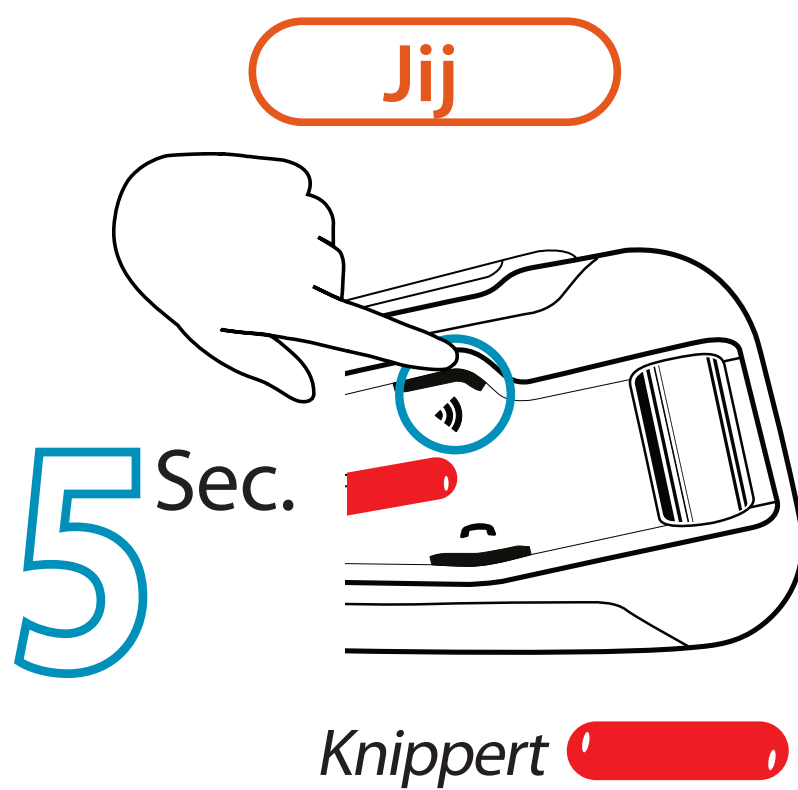

Initiëren intercomkoppeling

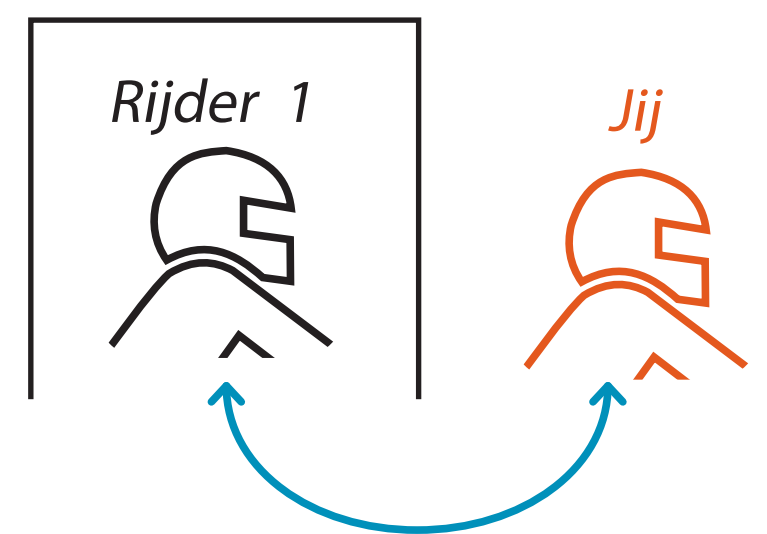

Toevoeging van 3e rijder

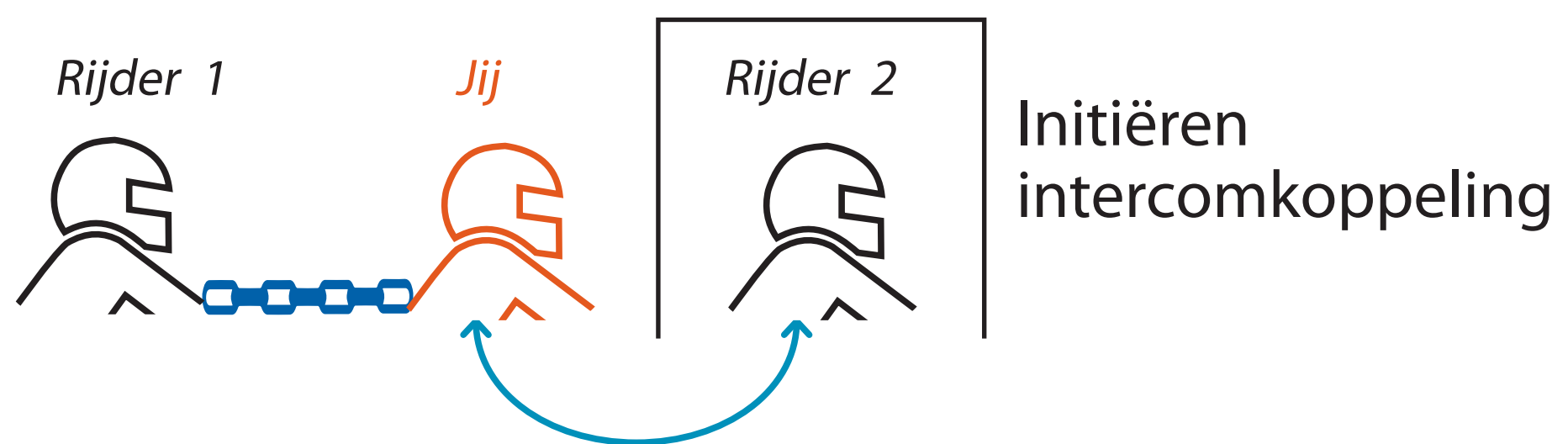
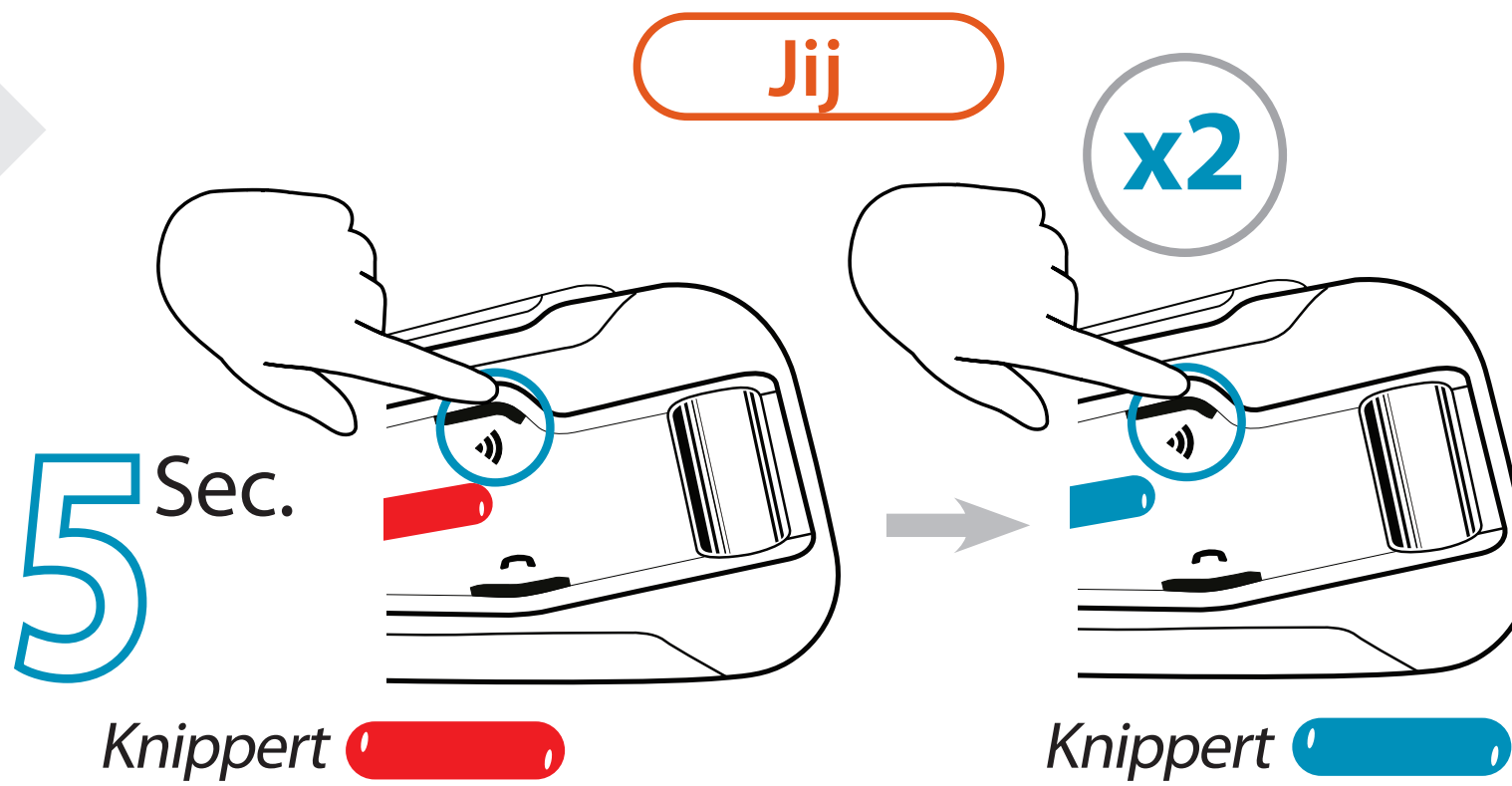

Toevoeging van 4e rijder

Rijder 2 maakt verbinding met rijder 3 op het vrije kanaal van rijder 2

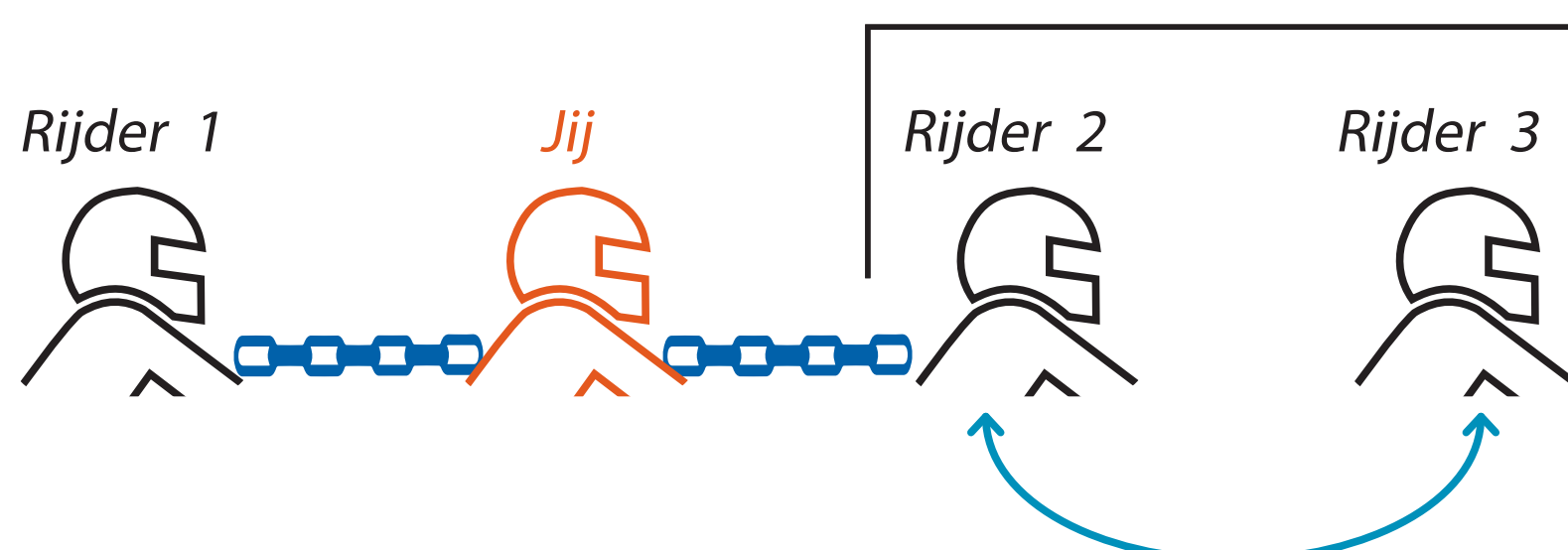

Stel een universele intercom in

Controleer of je in  Bluetooth Modus

Knippert 

 Bluetooth / DMC
Intercom-modus

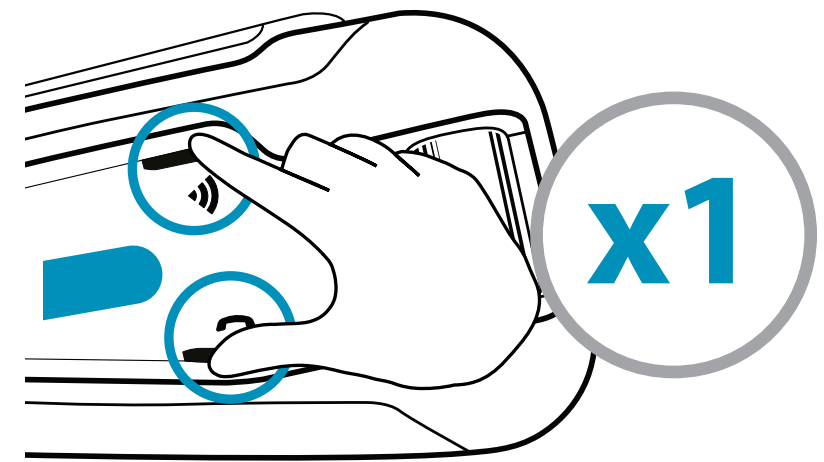

2-weg
koppeling

5 Sec.

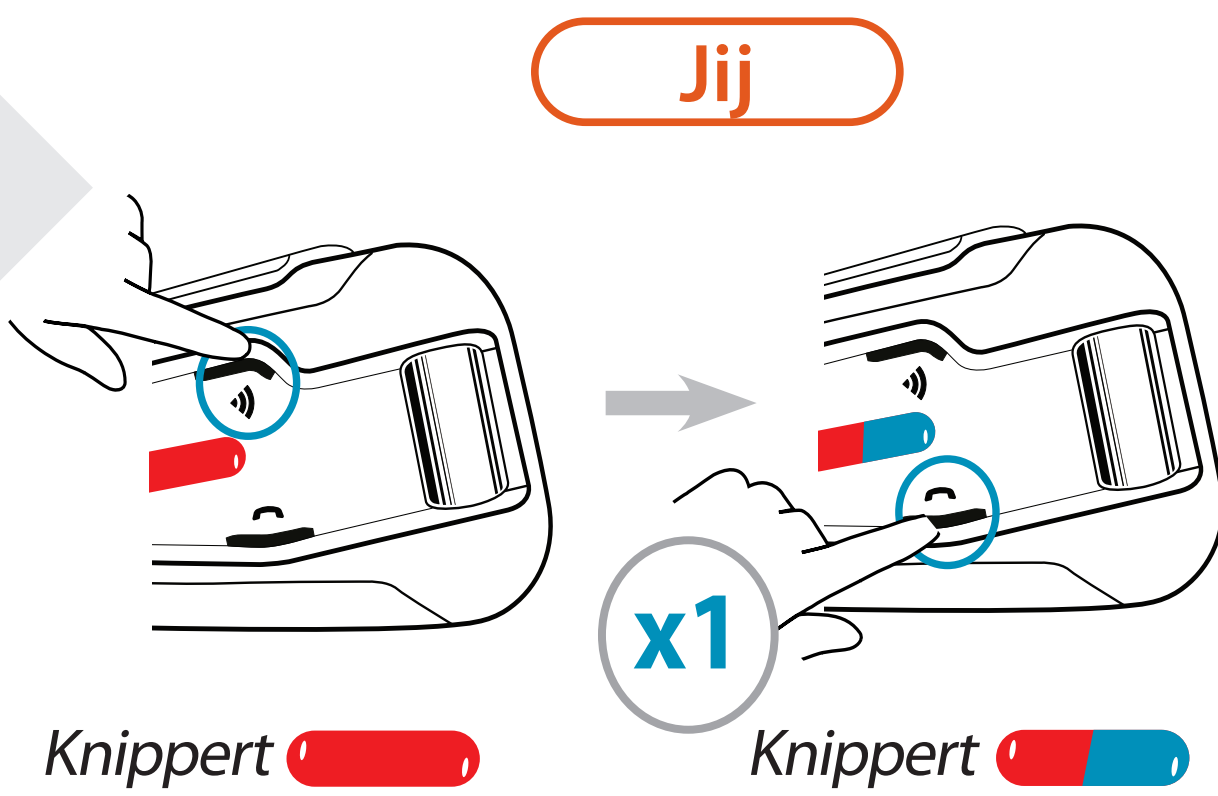

Start
telefoonkoppeling

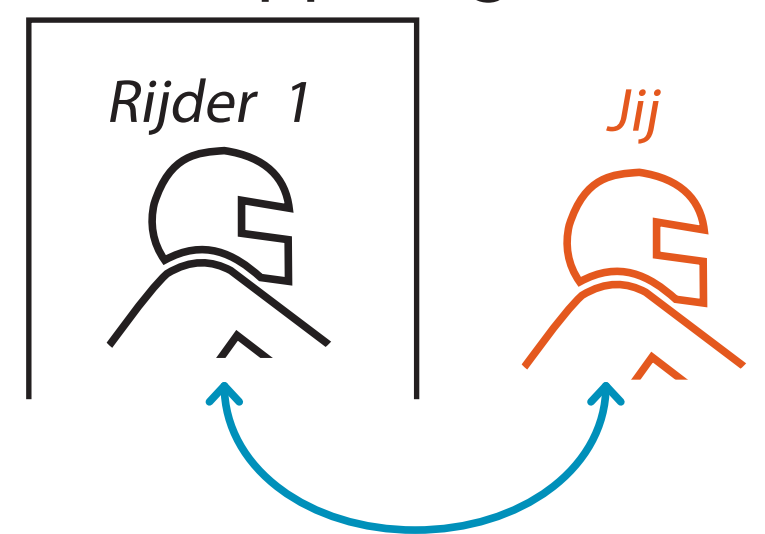

Toevoeging
van 3e rijder

5 Sec.

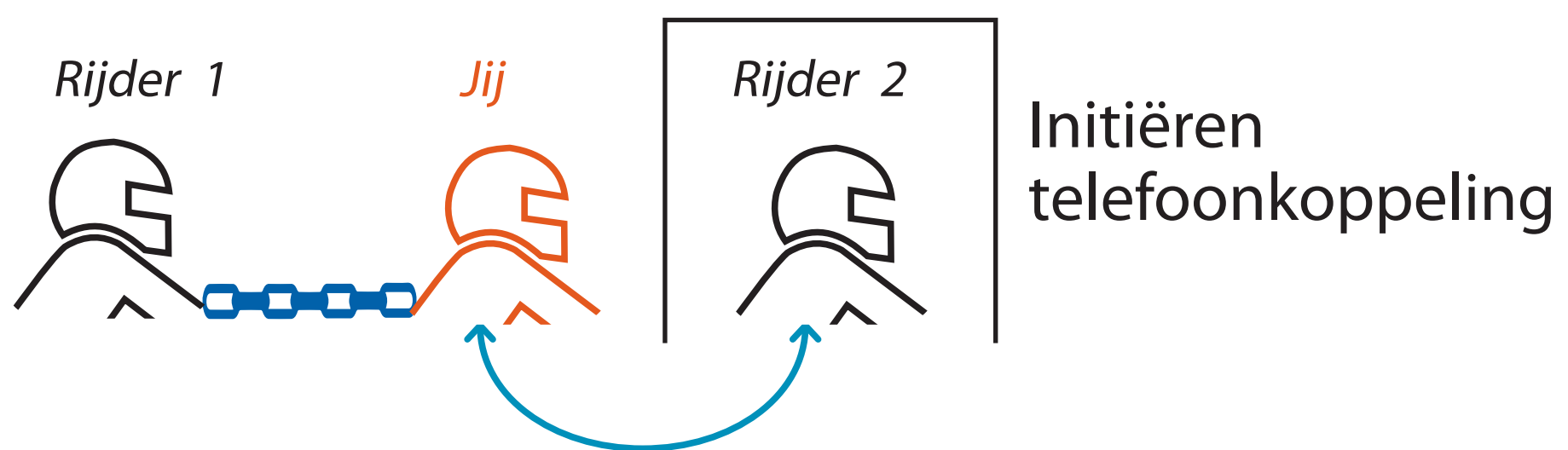
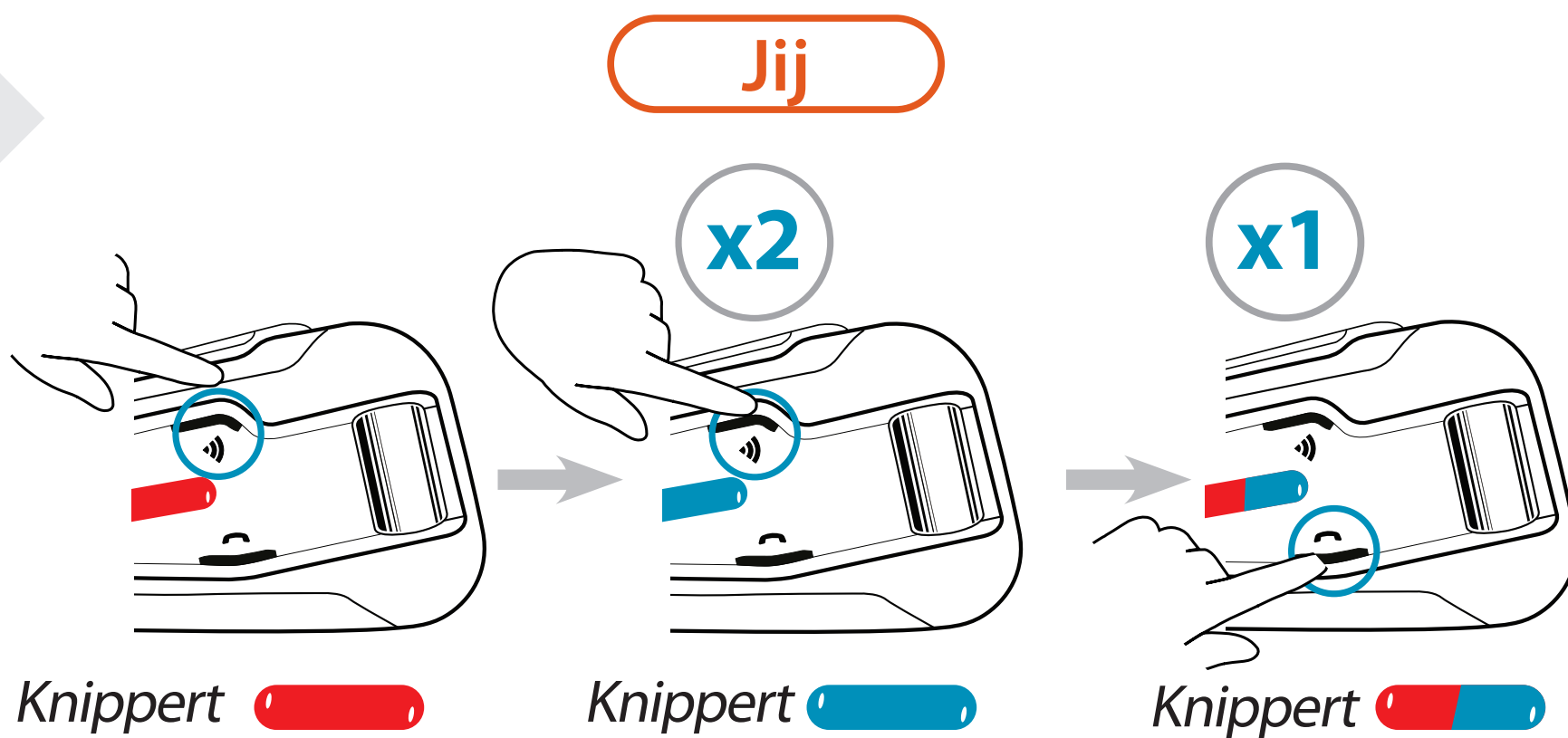

Toevoeging
van 4e rijder

Rijder 2 maakt verbinding met rijder 3 op het vrije kanaal van rijder 2

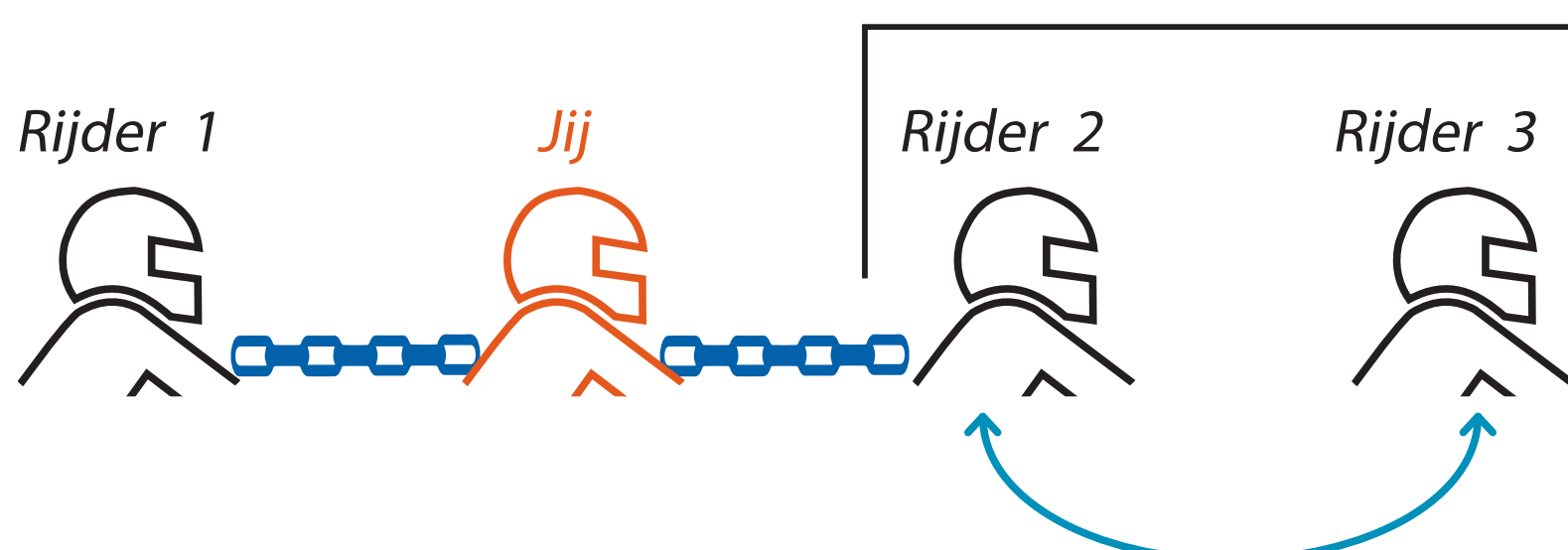

Intercom



Beginnen / Eindigen / Rijder 1 toevoegen

Rijder 1

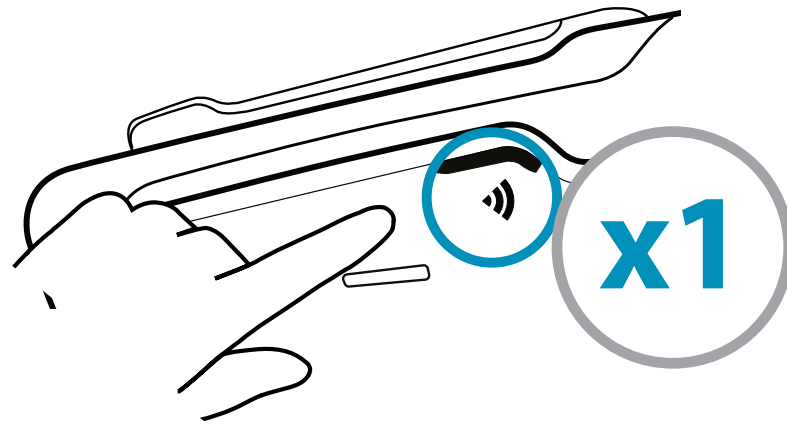

Beginnen / Eindigen / Rijder 2 toevoegen

Rijder 2

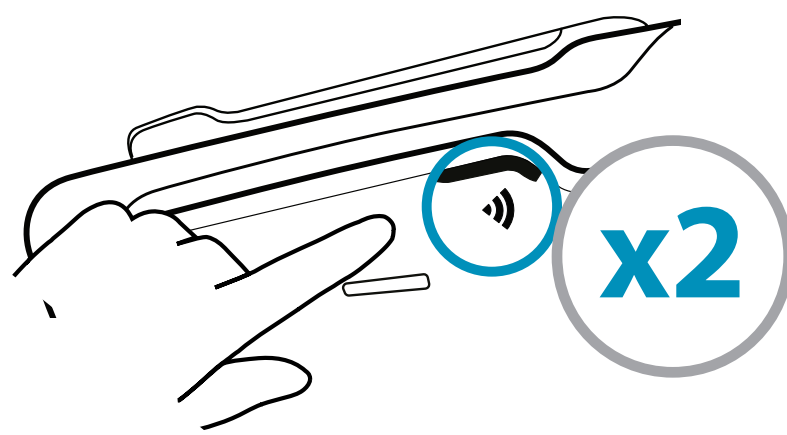

Initieer 4-weg intercom conferentie

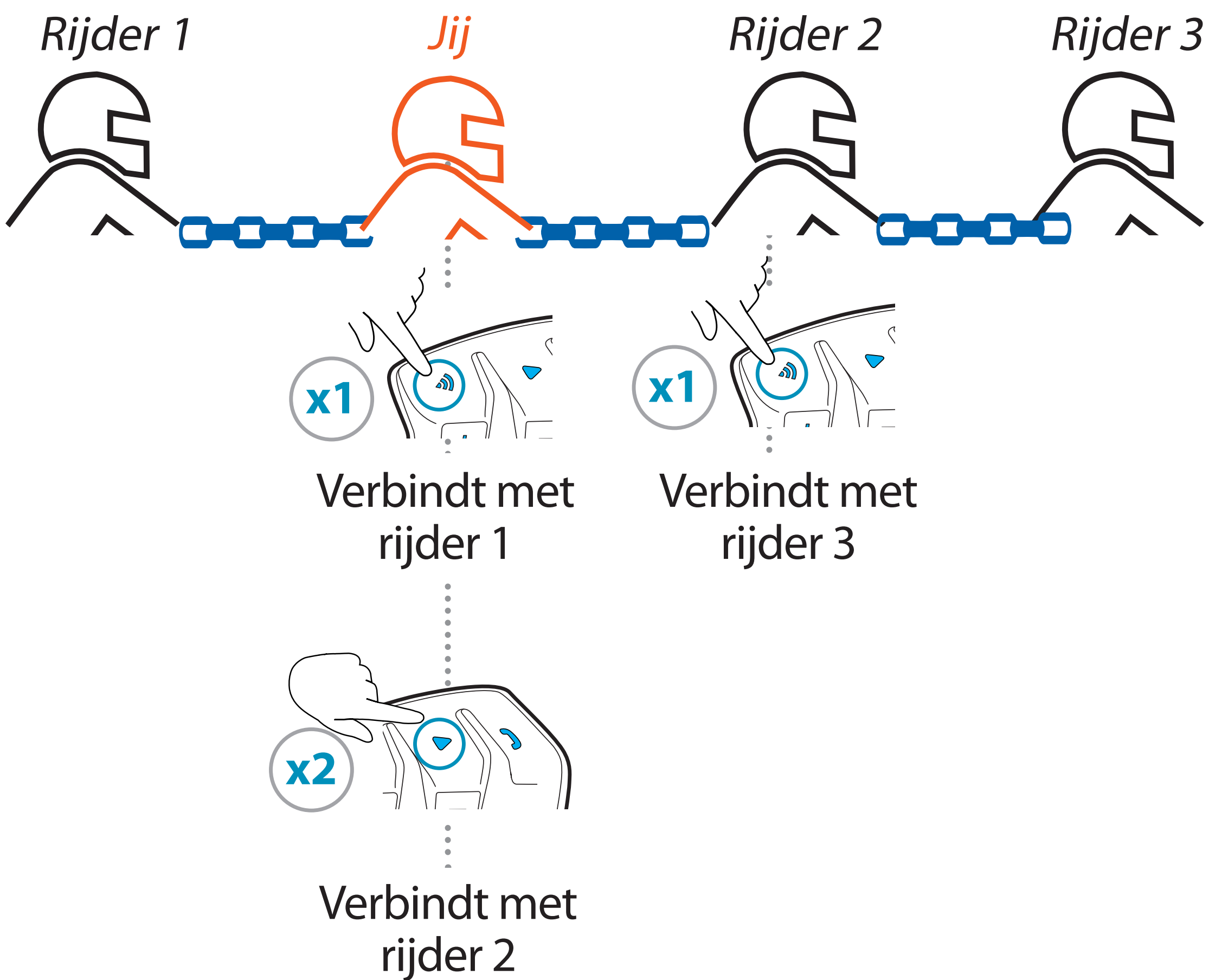

Spraakcommando's Altijd aan!



- "Hey Cardo, **radio on**"
- "Hey Cardo, **radio off**"
- "Hey Cardo, **next station**"
- "Hey Cardo, **previous station**"



- "Hey Cardo, **music on**"
- "Hey Cardo, **music off**"
- "Hey Cardo, **next track**"
- "Hey Cardo, **previous track**"



- "Hey Cardo, **volume up**"
- "Hey Cardo, **volume down**"
- "Hey Cardo, **mute audio**"
- "Hey Cardo, **unmute audio**"



- "Hey Cardo, **speed dial**"
- "Hey Cardo, **redial number**"
- **Answer**
- **Ignore**



- "Hey Siri"
- "Ok Google"



- "Hey Cardo, **battery status**"
- "Hey Cardo, **call intercom**"

Fabrieksreset

5^{Sec.}

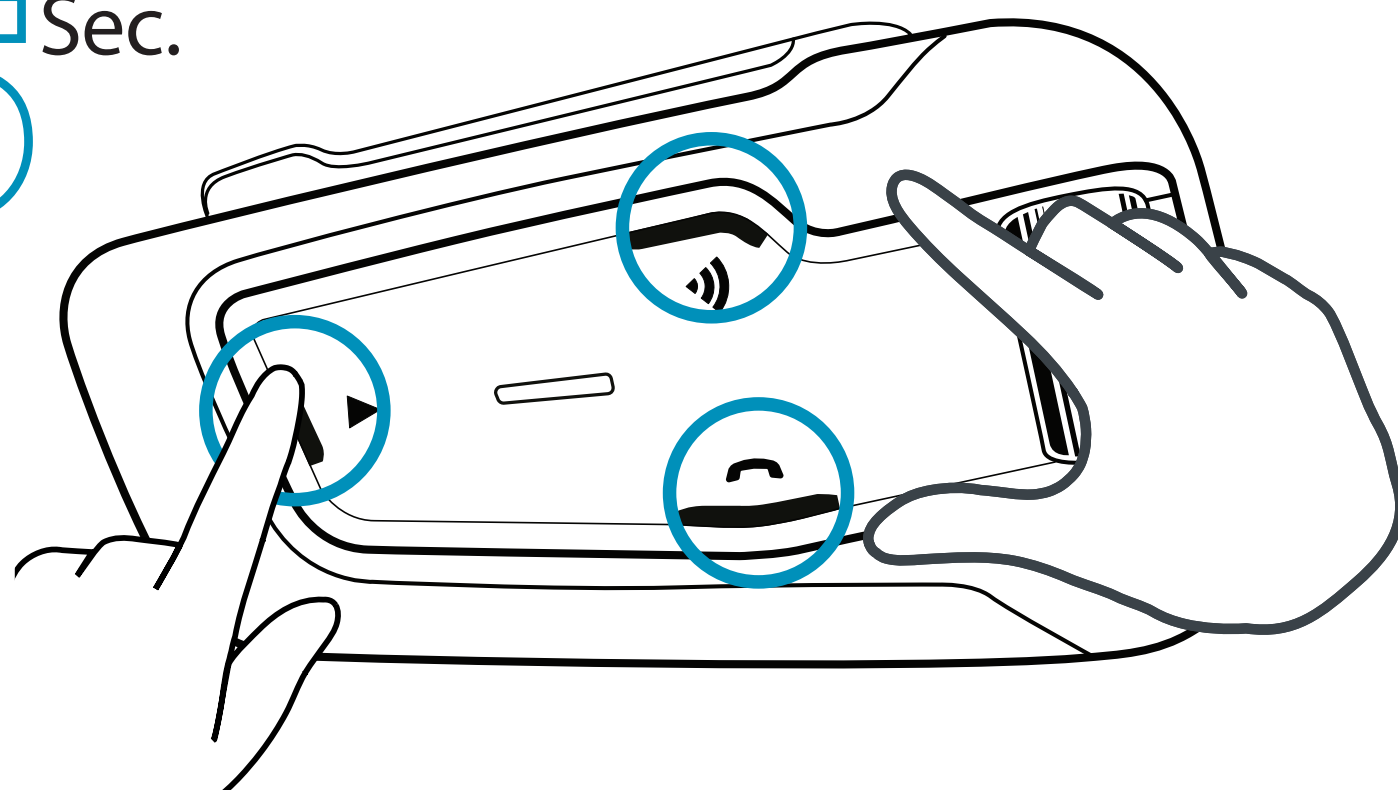

Knippert x5: 

Cardo Mobiele App

- Eenvoudige configuratie
- Afstandsbediening
- On-the-go aanpassen van instellingen
- Beheer van DMC-groepen

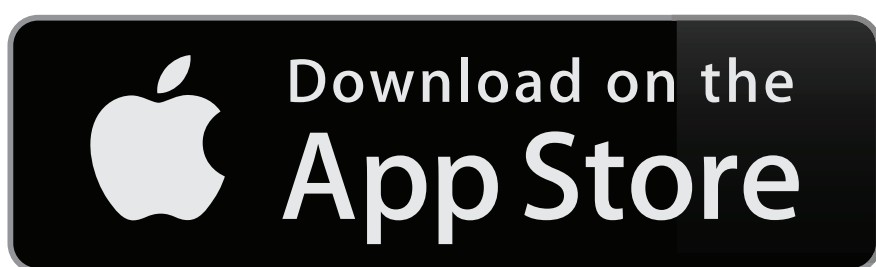

Cardo
Connect
App



Volledige versie van de handleiding
cardosystems.com/support

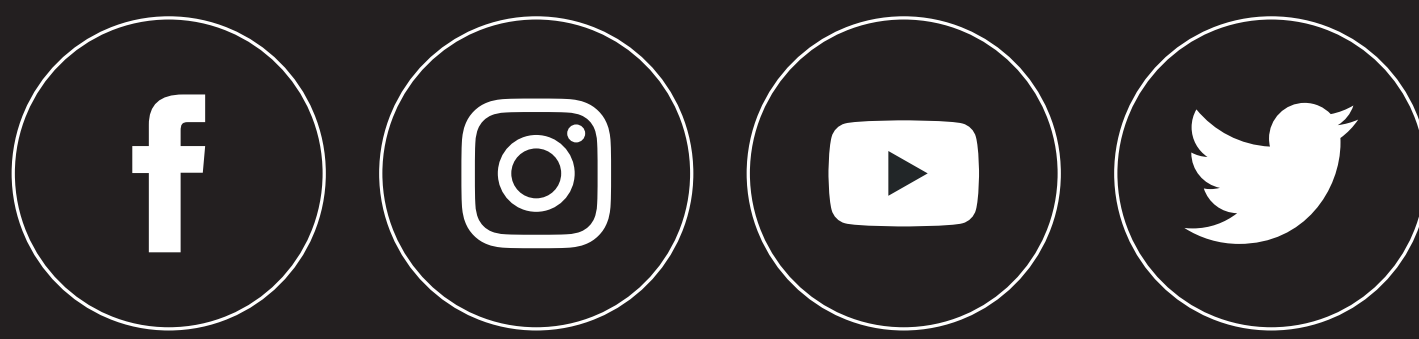

cardosystems.com