

688FZ-KZ688

MONORACK SPECIFICO - SPECIFIC MONORACK  
MONORACK SPECIFIQUE - SPEZIFISCHES MONORACK - MONORACK ESPECIFICO

**BMW R1200R** '07/'08

ISTRUZIONI DI MONTAGGIO - MOUNTING INSTRUCTIONS  
INSTRUKTIONS DE MONTAGE - BAUANLEITUNG - INSTRUCCIONES DE MONTAJE

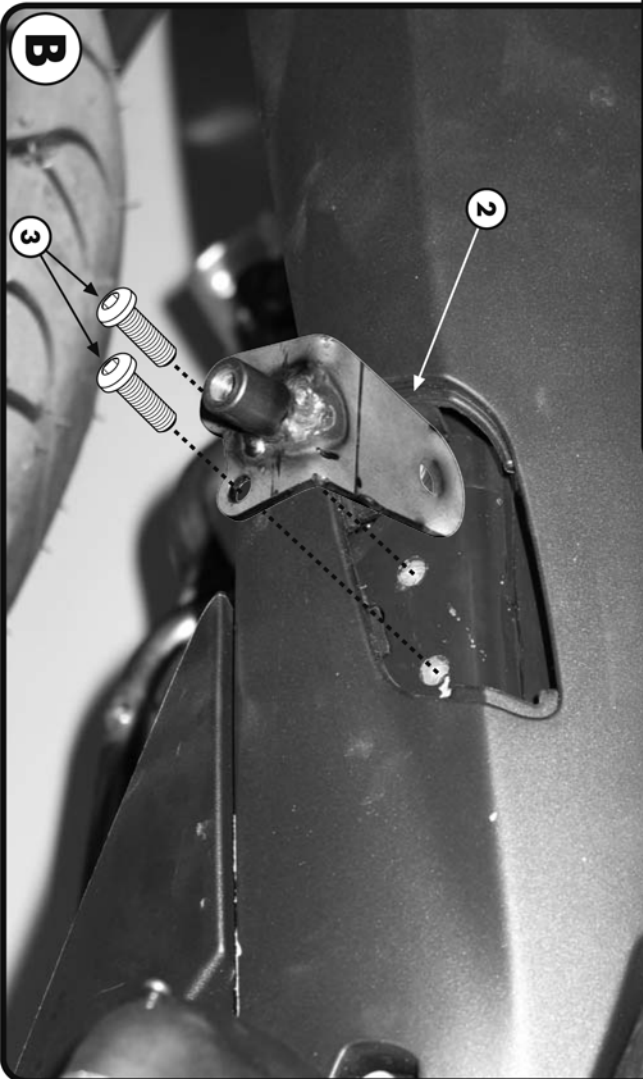
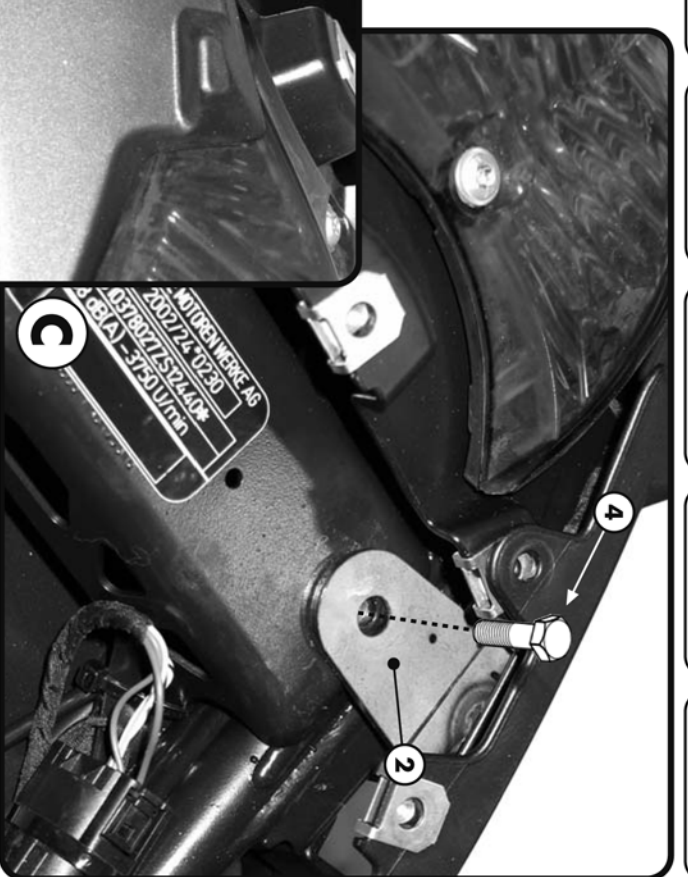
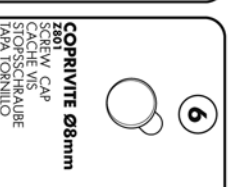
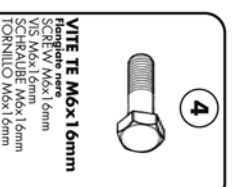
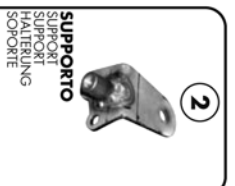
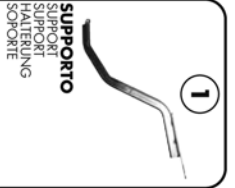

**A**  
**ATTENZIONE**  
PESO MASSIMO SOPPORTABILE  
10Kg.

**WARNING**  
MAX. LOADING OF THE CARRIER  
10Kg.(21lbs)

**ATTENTION**  
CHARGE MAXIMALE 10Kg.

**ACHTUNG**  
MAXIMALE BELASTUNG 10Kg.

**¡ATENCIÓN!**  
CARGA MÁXIMA AUTORIZADA  
10Kg.

**SUPPORTO**  
SUPPORT  
SUPPORT  
HALTERUNG  
SOPORTE  
**Q.TY n.2(Dx-Sx)**

**SUPPORTO**  
SUPPORT  
SUPPORT  
HALTERUNG  
SOPORTE  
**Q.TY n.2(Dx-Sx)**

**VITE T8E1 M6x16mm**  
VIS M6x16mm  
SCHRAUBE M6x16mm  
TORNILLO M6x16mm  
**Q.TY n.4**

**VITE TE M6x16mm**  
Flinghiera nera  
SCHRÄUBEN  
SCHRAUBE M6x16mm  
TORNILLO M6x16mm  
**Q.TY n.4**

**VITE TCE1 M8x25mm**  
SCHRÄUBEN  
SCHRAUBE M8x25mm  
TORNILLO M8x25mm  
**Q.TY n.2**

**COPRIVITE Ø8mm**  
Z801  
SCHEIBE  
SCHRAUBENKAPPE  
TAPA TORNILLO  
**Q.TY n.2**

**C**



**GOMMA SAGOMATA**  
RUBBER CUSHION  
CAOUTCHOUC PROFITE  
GFORMATE GUMMI  
GOMA PROTECTORA  
**Q.TY n.2(Dx-Sx)**

**PARTICOLARI INCLUSI NEL KIT VITERIA DELLA PIASTRINA**  
COMPONENTS INCLUDED IN THE FITTING KIT OF THE PLATE  
PIECES INCLUES DANS LE KIT DE VIS DE LA PLAQUE  
DIE EINZELNEN TEILE SIND BEI MONTAGE ZU INSTALLIEREN  
DESPECES INCLUIDOS EN EL KIT DE PARRILLA  
**Q.TY n.-**

688FZ-KZ688

MONORACK SPECIFICO - SPECIFIC MONORACK  
MONORACK SPECIFIQUE - SPECIFISCHES MONORACK - MONORACK ESPECIFICO

**BMW R1200R '07/'08**

ISTRUZIONI DI MONTAGGIO - MOUNTING INSTRUCTIONS  
INSTRUCTIONS DE MONTAGE - BAUANLEITUNG - INSTRUCCIONES DE MONTAJE

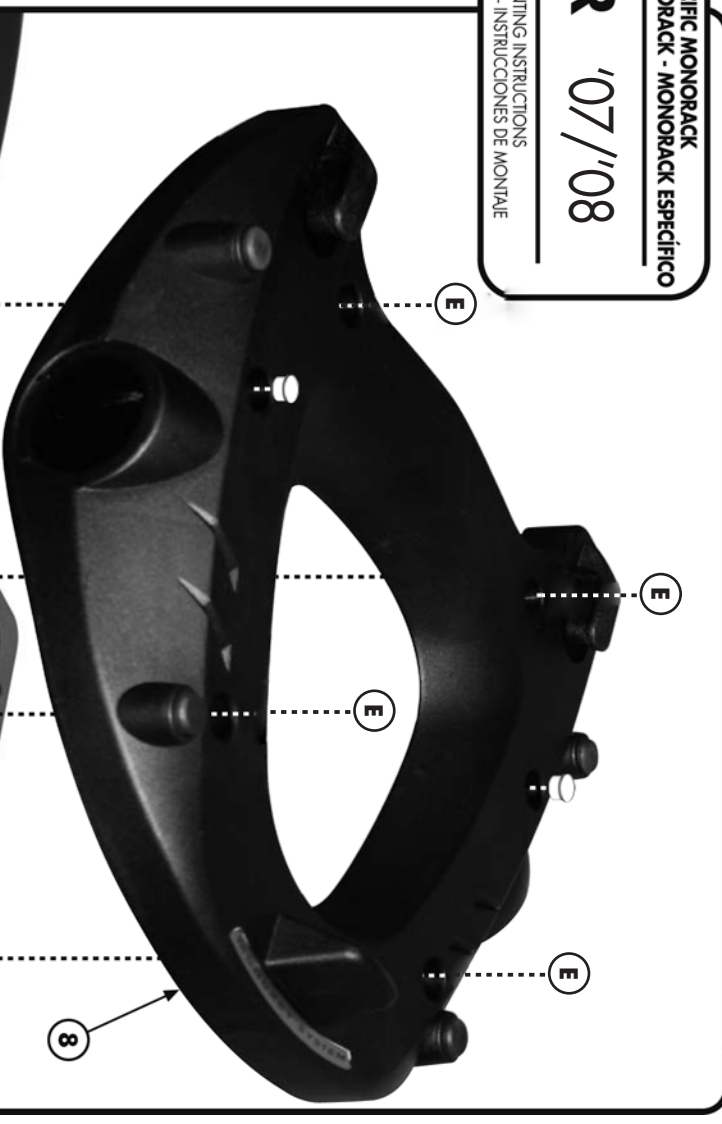
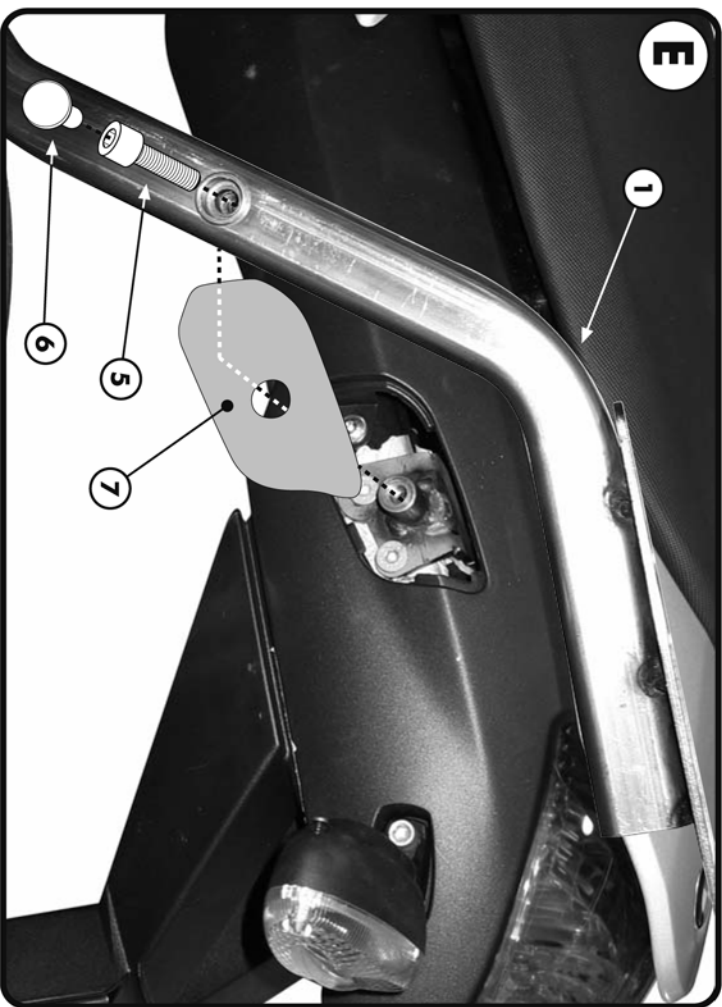

MONORACK SPECIFICO - SPECIFIC MONORACK  
 MONORACK SPECIFIQUE - SPEZIFISCHES MONORACK - MONORACK ESPECIFICO

# BMW R1200R '07/'08

ISTRUZIONI DI MONTAGGIO - MOUNTING INSTRUCTIONS  
 INSTRUCTIONS DE MONTAGE - BAUANLEITUNG - INSTRUCCIONES DE MONTAJE

**9**

**GOMMINO**  
 RUBBER  
 CAOUTCHOUC  
 GUMMI  
 GOMA

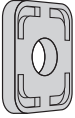

**Q.TY n.4**

**10**

**RONDELLA IN GOMMA**  
 RUBBER WASHER  
 RONDELLE EN GOMME  
 GUMMISCHERBE  
 ARANDELA DE GOMA



**Q.TY n.4**

**11**

**DISTANZIALE Ø11x11mm**  
 SPACER  
 ENTRETOISE  
 DISTANZSTÜCK  
 DISTANCIADOR



**Q.TY n. 4**

**12**

**VITE TCEI M6x35mm**  
 SCREW  
 VIS  
 SCHRAUBE  
 TORNILLO



**Q.TY n.X**

**13**

**RONDELLA Ø6x20mm**  
 WASHER  
 RONDELLE  
 SCHEIBE  
 ARANDELA



**Q.TY n.4**

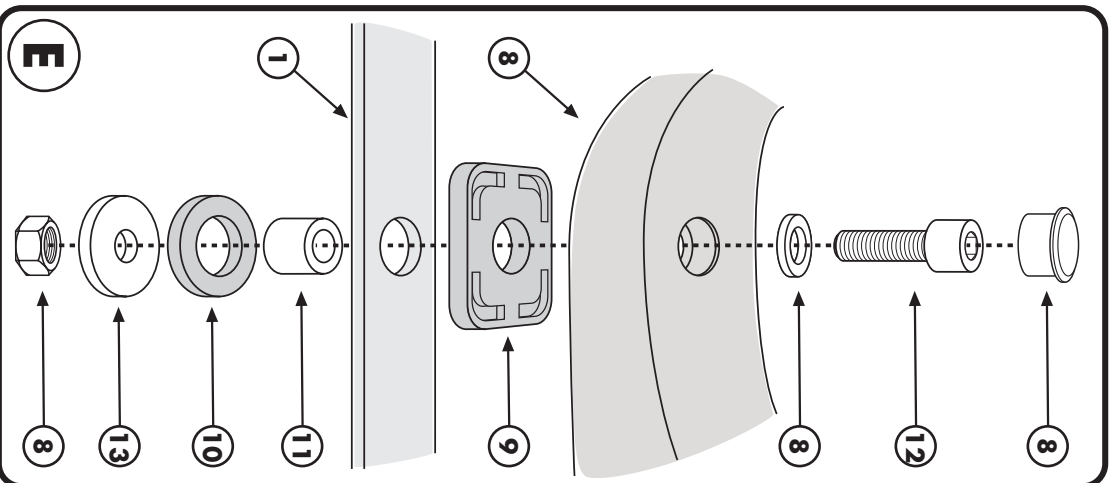

**MONORACK SPECIFICO - SPECIFIC MONORACK**  
**MONORACK SPECIFIQUE - SPEZIFISCHES MONORACK - MONORACK ESPECÍFICO**

**BMW R1200R '07/'08**

ISTRUZIONI DI MONTAGGIO - MOUNTING INSTRUCTIONS  
 INSTRUCTIONS DE MONTAGE - BAUANLEITUNG - INSTRUCCIONES DE MONTAJE

## I ISTRUZIONI DI MONTAGGIO

1. SMONTARE IL PARTICOLARE EVIDENZIATO IN FOTOGRAFIA A;
2. MONTARE IL SUPPORTO N°2 COME INDICATO IN FOTOGRAFIA B e C QUIDI RIMONTARE IL PARTICOLARE EVIDENZIATO IN FOTOGRAFIA A;
3. MONTARE IL MONORACK COME INDICATO IN FOTOGRAFIA D ed E;
4. MONTARE LA PIASTRA PORTAVALLIGIA (NON INCLUSA) COME INDICATO IN FOTOGRAFIA F;
5. ULTIMARE IL MONTAGGIO CONTROLLANDO CHE TUTTE LE VITI SIANO SERRATE BENE.

## GB MOUNTING INSTRUCTIONS

1. REMOVE THE PART INDICATED IN PICTURE A;
2. MOUNT THE SUPPORT N°2 AS INDICATED IN PICTURE B AND C AND THEN REMOUNT THE PART INDICATED IN PICTURE A;
3. MOUNT THE MONORACK AS SHOWN IN PICTURE D AND E;
4. MOUNT THE PLATE (NOT INCLUDED) AS SHOWN IN PICTURE F;
5. LASTLY CHECK THAT ALL SCREWS HAVE BEEN TIGHTENED.

## F INSTRUCTIONS DE MONTAGE

1. DEMONTER LA PIÈCE MISE EN EVIDENCE SUR LA PHOTO A;
2. MONTER LES SUPPORTS N°1 b02 COMME INDIQUE EN PHOTO B ET C;
3. MONTER LE MONORACK COMME INDIQUE EN PHOTO D ET E;
4. MONTER LA PLATINE (NON INCLUSE) COMME INDIQUE EN PHOTO F;
5. TERMINER LE MONTAGE EN CONTRÔLANT LE BON SERRAGE DE TOUTES LES VIS.

## D BAUANLEITUNG

1. ENTFERNEN SIE DAS TEIL GEZEIGT IM BILD A;
2. MONTIEREN SIE DIE HALTERUNG NR. 2 WIE IM BILD B UND C BESCHRIEBEN, DANACH BEFESTIGEN SIE DAS TEIL VOM BILD A WIEDER;
3. MONTIEREN SIE DAS MONORACK WIE IM BILD D UND E BESCHRIEBEN;
4. MONTIEREN SIE DIE PLATTE (NICHT VORHANDEN) WIE IM BILD F BESCHRIEBEN;
5. ZULETZT ÜBERPRÜFEN SIE, DASS ALLE SCHRAUBEN FESTGEZOGEN WURDEN.

## ES

### INSTRUCCIONES DE MONTAJE

1. DESMONTAR LA PIEZA MOSTRADA EN LA IMAGEN A;
2. MONTAR EL SOPORTE N°1 b02 TAL Y COMO SE INDICA EN LA IMAGEN B Y C Y ENTONCES VOLVER A MONTAR LA PIEZA DE LA IMAGEN A;
3. MONTAR EL MONORACK TAL Y COMO SE INDICA EN LA IMAGEN D Y E;
4. MONTAR LA PARRILLA PORTAEQUIPALES (NO INCLUIDA) TAL Y COMO SE INDICA EN LA IMAGEN F;
5. TERMINAR EL MONTAJE ASEGURANDOSE QUE TODOS LOS TORNILLOS HAN SIDO APRETADOS CORRECTAMENTE.