







PORTAVALIGIA SPECIFICO - SPECIFIC CASE HOLDER
 PORTE-VALISE SPECIFIQUE - SPEZIFISCHER KOFFER-TRÄGER
 PORTA-EQUIPALE ESPECÍFICO

KAWASAKI GTR1400cc '07

ISTRUZIONI DI MONTAGGIO - MOUNTING INSTRUCTIONS
 INSTRUCTIONS DE MONTAGE - BAUANLEITUNG - INSTRUCCIONES DE MONTAJE

- 01**
SUPPORTO
 SUPPORT
 SUPPORT
 SOKORTE

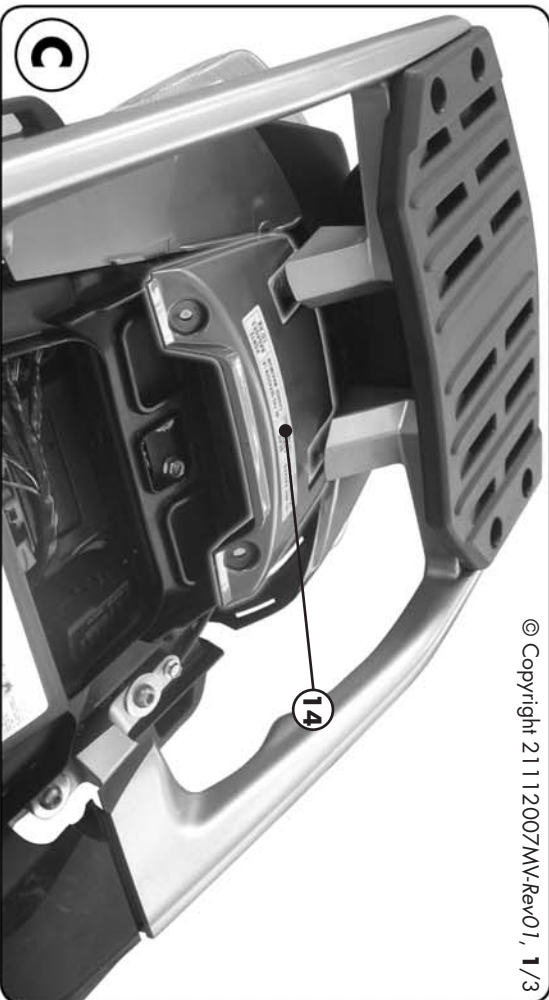
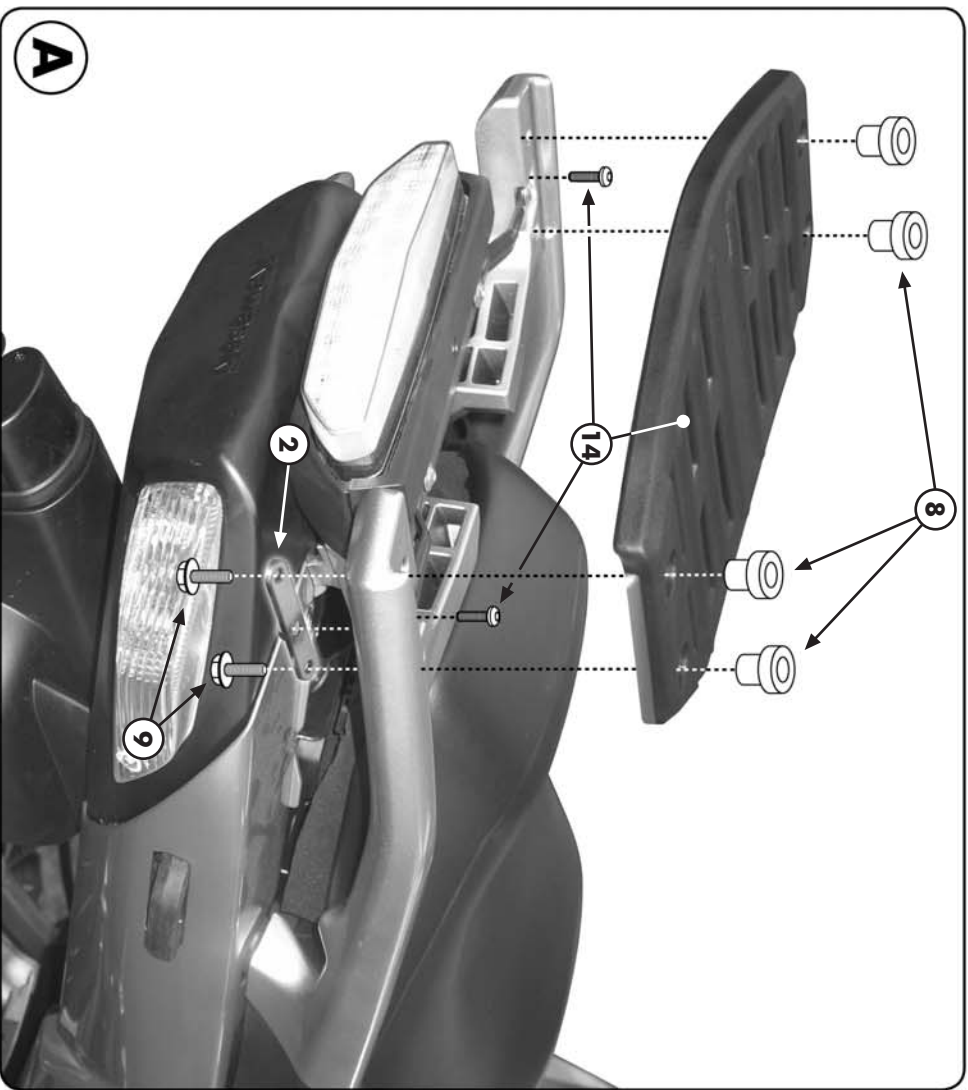
 Qty n.2(dx. sx)
- 02**
PIASTRINA
 PETITE PLAQUE
 KLEBEPLATTE
 PLACUETA

 Qty n.2
- 03**
SUPPORTO
 SUPPORT
 SUPPORT
 SOKORTE

 Qty n.2(dx. sx)
- 04**
COPRIFORO
 BOLT CAP
 GACHE TROU
 STOPSCHLÜSSEL
 TAPA ABUJERO
 Z802

 Qty n.2
- 05**
VITE TCEI
 SCREW
 SCHRAUBE
 TORNILLO
 M8x25mm

 Qty n.2
- 06**
RONDELLA
 WASHER
 KONDELLE
 SCHRAIBELE
 ARANDELA
 Ø8x14 mm

 Qty n.6
- 07**
VITE TBEI
 SCREW
 SCHRAUBE
 TORNILLO
 M8x16mm

 Qty n.2



© Copyright 21112007/MV-Rev01, 1/3

A

ATTENZIONE: PESO MASSIMO SOPPORTABILE 10Kg.
WARNING: MAX. LOADING OF THE CARRIER 10Kg. (21lbs)
ACHTUNG: CHARGE MAXIMALE 10Kg.
!ATENCIÓN!: CARGA MÁXIMA AUTORIZADA 10Kg.

KAWASAKI GTR1400cc '07

ISTRUZIONI DI MONTAGGIO - MOUNTING INSTRUCTIONS
 INSTRUCCIONES DE MONTAJE - BALANZENTUNG - INSTRUCIONES DE MONTAJE

PORTAVALIGIA SPECIFICO - SPECIFIC CASE HOLDER
 PORTE-VALISE SPECIFIQUE - SPEZIFISCHER KOFFER-TRÄGER
 PORTA-EQUIPAJE ESPECIFICO

08
DISTANZIALE
 SPACER
 ENTRE-OSSE
 DISTANCIADOR



V677 - Ø16x33mm
 Ribassolo Ø10x16mm
 M8 - M6
Q.ty n.4

09
VITE TEF
 SCREW
 VIS
 SCHRAUBE
 TORNILLO

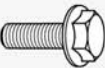

M6x16mm
Q.ty n.4

10
DADO
 ANELLOCCANTE
 BOIT
 KÖRPER
 KÖRPER
 TUERCA



M8
Q.ty n.6

F

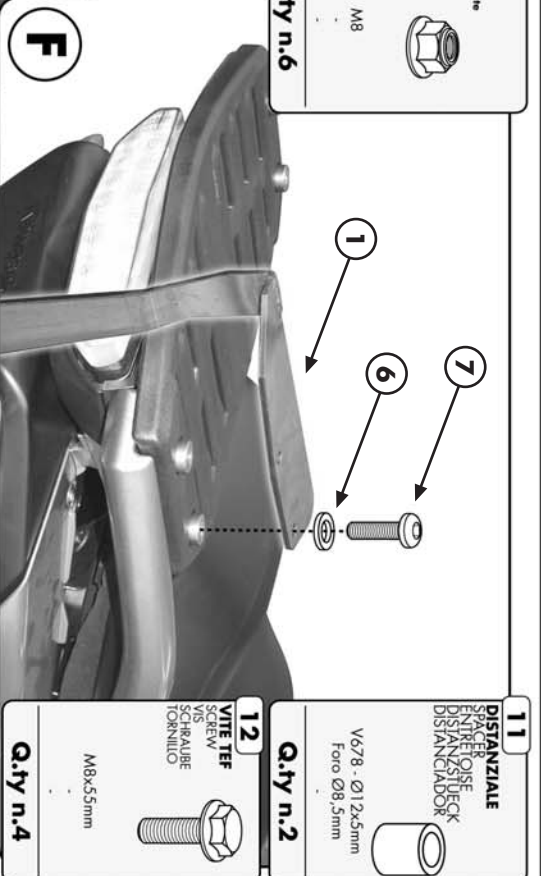

11
DISTANZIALE
 SPACER
 ENTRE-OSSE
 DISTANCIADOR



V678 - Ø12x5mm
 Foro Ø8,5mm
Q.ty n.2

12
VITE TEF
 SCREW
 VIS
 SCHRAUBE
 TORNILLO

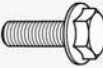

M8x5,5mm
Q.ty n.4

E



13
PIASTRA MONKEY
 PLATE
 PLATE
 PLATTE
 PARRILLA



Z230M
Q.ty n.1

14
COMPONENTI ORIGINALI
 ORIGINAL PARTS
 PARTIES ORIGINALES
 ORIGINAL BAUTEILE
 COMPONENTES ORIGINALES

15
VITE TEF
 SCREW
 VIS
 SCHRAUBE
 TORNILLO



M8x3,5mm
Q.ty n.-

H

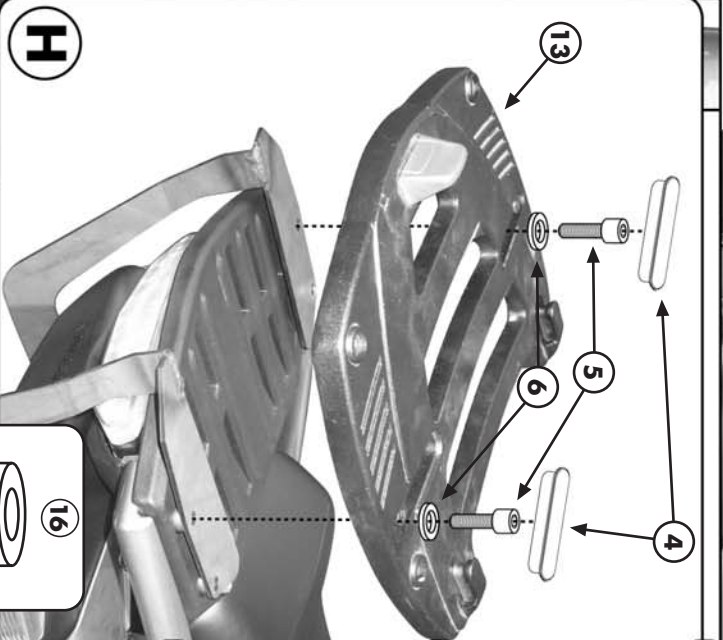

16
MOUSSE PROTETTIVA
 PROTECTOR
 PROTECTOR
 PROTECTOR
 MOUSSE DE PROTECTION
 SCHUTZHAUM
 ESPUMA ADHESIVA PROTECTORA



Q.TY n.2

D



1
11
16

G

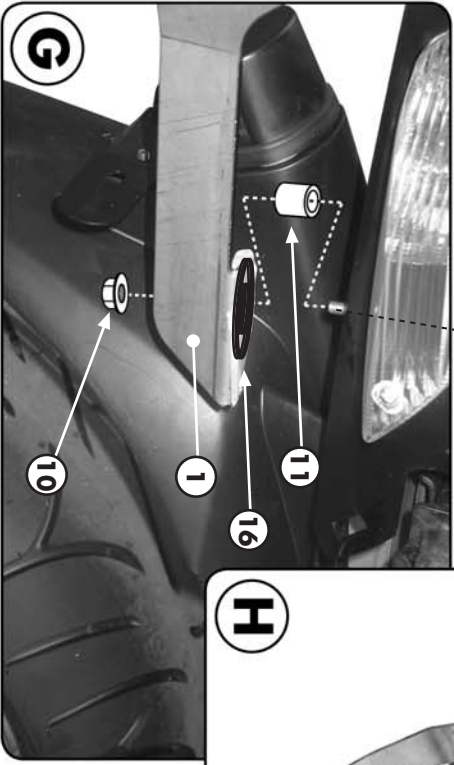

10
11

SR410 · KR410

PORTAVALLIGIA SPECIFICO · SPECIFIC CASE HOLDER
PORTE-VALISE SPECIFIQUE · SPEZIFISCHER KOFFER-TRÄGER
PORTA-RUPIALE SPECIFICO

KAWASAKI GTR1400cc '07

ISTRUZIONI DI MONTAGGIO · MOUNTING INSTRUCTIONS
INSTRUCIONS DE MONTAGE · BAUANLEITUNG · INSTRUCCIONES DE MONTAJE

I ISTRUZIONI DI MONTAGGIO

1. SMONTARE LA PIASTRA ORIGINALE INDICATA IN FOTOGRAFIA A E RIMONTATELA ESEGUENDO IL MONTAGGIO PROPOSTO;
2. SMONTARE LE PARTI ORIGINALI EVIDENZIATE IN FOTOGRAFIA B e C;
3. ALLARGARE I FORI EVIDENZIATI IN FOTOGRAFIA D FINO AL DIAMETRO DI 12mm;
4. EFFETTUARE IL MONTAGGIO PROPOSTO IN FOTOGRAFIA E1 SOSTITUENDO LE VITI ORIGINALI CON QUELLE INDICATE NELL'IMMAGINE (PARTICOLARE N°12);
5. RIMONTARE LE PARTI DI CARENATURA SMONTATE IN PRECEDENZA;
6. MONTARE IL PARTICOLARE N°1 COME INDICATO IN FOTOGRAFIA G ED F;
7. MONTARE LA PIASTRA PORTAVALLIGIA COME INDICATO IN FOTOGRAFIA H;
8. ULTIMARE IL MONTAGGIO VERIFICANDO CHE TUTTE LE VITI SIANO SERRATE BENE (VITI M6=9,6Nm - VITI M8=23Nm) E CHE IL TAPPO ANTIFURTO ED I GOMMINI SIANO MONTATI CORRETTAMENTE SULLA PIASTRA.

GB MOUNTING INSTRUCTIONS

1. REMOVE THE ORIGINAL PLATE SHOWN IN PICTURE A AND RE MOUNT IT AGAIN UPSIDE DOWN;
2. REMOVE THE ORIGINAL PARTS MARKED IN PICTURES B AND C;
3. WIDEN THE HOLES MARKED IN PICTURE D TILL THE DIAMETER OF 12mm;
4. CARRY OUT THE MOUNTING YOU SEE IN PICTURE E1 REPLACING THE ORIGINAL SCREWS WITH THE ONES YOU SEE IN THE PICTURE (DETAIL N°12);
5. SET AGAIN THE FAIRING PARTS REMOVED PREVIOUSLY;
6. MOUNT DETAIL N°1 AS YOU CAN SEE IN PICTURES G AND F;
7. MOUNT THE PLATE AS YOU CAN SEE IN PICTURE H;
8. CHECK THAT ALL THE SCREWS ARE WELL TIGHTENED (SCREWS M6=9,6Nm - SCREWS M8=23Nm) AND CHECK ALSO THAT THE ANTI THEFT CAP AND THE RUBBERS ARE CORRECTLY POSITIONED ON THE CARRIER.

F INSTRUCTIONS DE MONTAGE

1. DEMONTER LA PLATINE D'ORIGINE INDIQUEE EN PHOTO A ET LA REMONTER EN EXECUTANT LE MONTAGE PROPOSE;
2. DEMONTER LES PIECES D'ORIGINE MARQUEES EN PHOTO B ET C;
3. ELARGIR LES TROUS MARQUES EN PHOTO D JUSQU'À UN DIAMETRE DE 12mm;
4. REALISER LE MONTAGE PROPOSE EN PHOTO E1 EN REMPLACANT LES VIS D'ORIGINE AVEC CELES INDIQUEES DANS LA PHOTO (PIECES N°12);
5. REMONTER LES PIECES DE CARENAGE DEMONTEES AUPARAVANT;
6. MONTER LA PIECE N°1 COMME INDIQUE EN PHOTO G ET F;
7. MONTER LA PLATINE PORTE-VALISE COMME INDIQUE EN PHOTO H;
8. TERMINER LE MONTAGE EN CONTROLANT LE BON SERRAGE DE TOUTES LES VIS (VIS M6=9,6Nm - VIS M8=23Nm) ET LE MONTAGE CORRECT DU BOUCHON AIVOL ET DES SILENT BLOCS SUR LA PLATINE.

D BAUANLEITUNG

1. DIE ORIGINALPLATTE DEMONTIEREN (BILD A). BEFESTIGEN SIE DIE PLATTE WIEDER, WIE BEI DER MONTAGE HINGEWIESEN.
2. DEMONTIEREN SIE DIE ORIGINALTEILE WIE IN DEN BILDER B UND C GEZEIGT.
3. ERWEITERN SIE DIE LOCHER (BILD D) BIS EINEM DURCHMESSER VON 12 MM.
4. FOLGEN SIE DER MONTAGE WIE IM BILD E1 GEZEIGT UND ERSETZEN SIE DIE ORIGINALSCHRAUBEN MIT DENEN IM BILD HINGEWIESEN (POSITION N°12).
5. MONTIEREN SIE DIE VERKLEIDUNGSTEILE, DIE VORHER ABGEBAUT WURDEN.
6. MONTIEREN SIE DIE POSITION N°1 WIE IN DEN BILDERN G UND F GEZEIGT.
7. MONTIEREN SIE DIE TOPCASE TRÄGERPLATTE WIE IM BILD H GEZEIGT.
8. ZULETZT ÜBERPRÜFEN SIE, DASS ALLE SCHRAUBEN FESTGEZOGEN WURDEN (SCHRAUBEN M6=9,6NM - SCHRAUBEN M8=23NM) UND DASS DER DIEBSTAHLSCHUTZ UND DIE GUMMISTOPSEL AUF DER PLATTE KORREKT MONTIERT WURDEN.

ES

INSTRUCCIONES DE MONTAJE

1. DESMONTAR LA PARRILLA ORIGINAL COMO MUESTRA LA FIGURA A Y VOLVER A MONTARLA COMO SE INDICA EN LA IMAGEN'N;
2. DESMONTAR LAS PARTES ORIGINALES QUE SE OBSERVAN EN LA IMAGEN B Y C;
3. AMPLIAR LOS AGUEROS INDICADOS EN LA IMAGEN G Y F;
4. EFECTUAR EL MONTAJE PROPUESTO EN LA IMAGEN E1 SUSTITUYENDO LOS TORNILLOS ORIGINALES POR LOS INDICADOS EN LA IMAGEN (REFERENCIA N° 12);
5. VOLVER A MONTAR LAS PARTES DE CARENADO DESMONTADAS EN ANTERIORMENTE;
6. MONTAR LA REFERENCIA N° 01 COMO MUESTRA LA IMAGEN G Y F;
7. MONTAR LA PARRILLA PORTAMALETAS COMO SE INDICA EN LA IMAGEN H;
8. TERMINAR EL MONTAJE COMPROBANDO QUE TODOS LOS TORNILLOS ESTEN BIEN APRETADOS (TORNILLOS M6=9,6Nm - TORNILLOS M8=23Nm) Y QUE LA TAPA ANTIRROBO Y LAS GOMAS ESTEN MONTADAS CORRECTAMENTE EN LA PARRILLA