

ATTACCHI SPECIFICI PER - SPECIFIC FITTING KIT FOR
 KIT DE MONTAGE SPECIFIQUE POUR - SPEZIFISCHER MONTAGEKIT FÜR
 ANCLAJE ESPECÍFICO PARA

HONDA FORZA 250 2008

ISTRUZIONI DI MONTAGGIO - MOUNTING INSTRUCTIONS
 INSTRUCTIONS DE MONTAGE - BAUANLEITUNG - INSTRUCCIONES DE MONTAJE

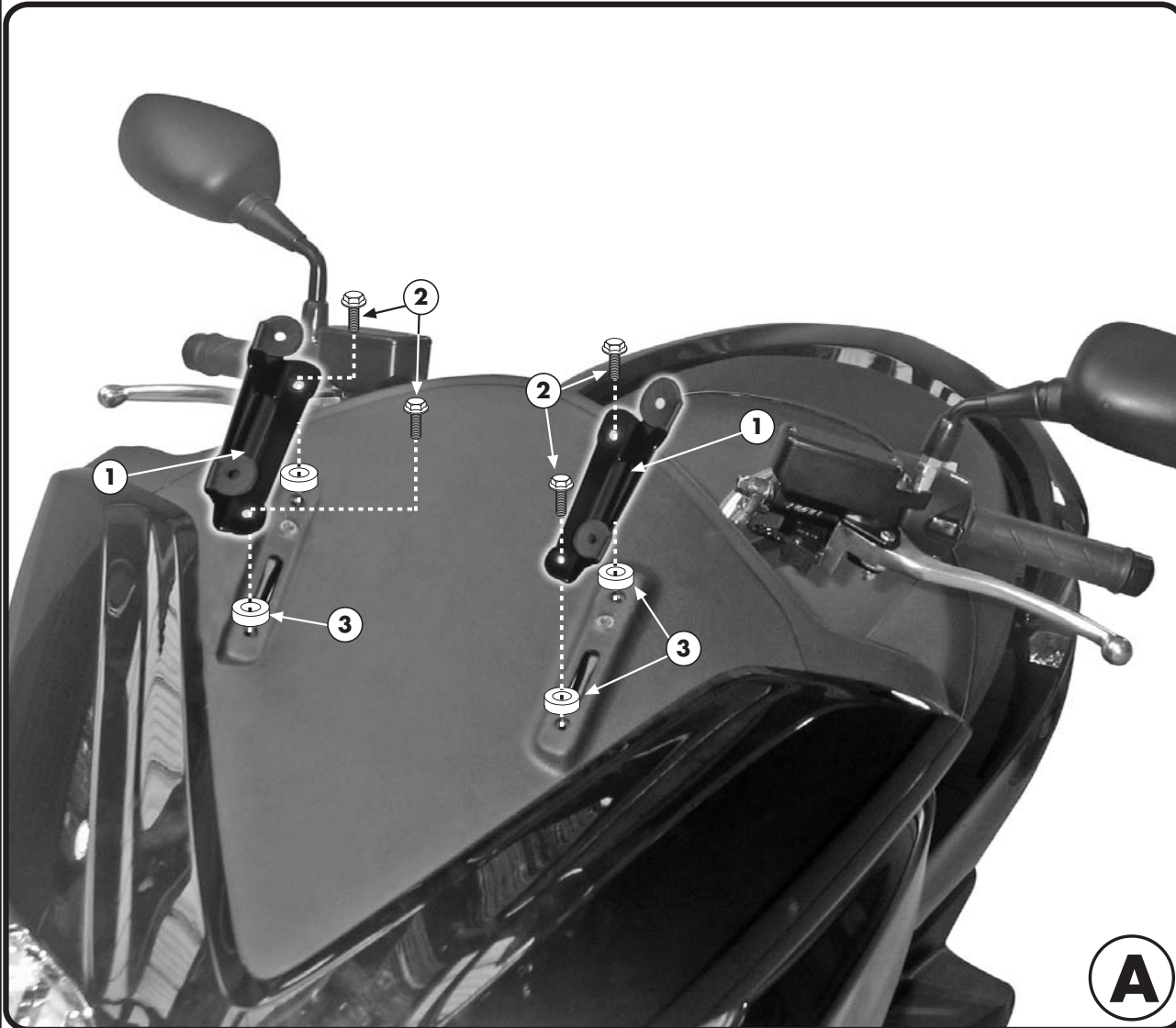

A

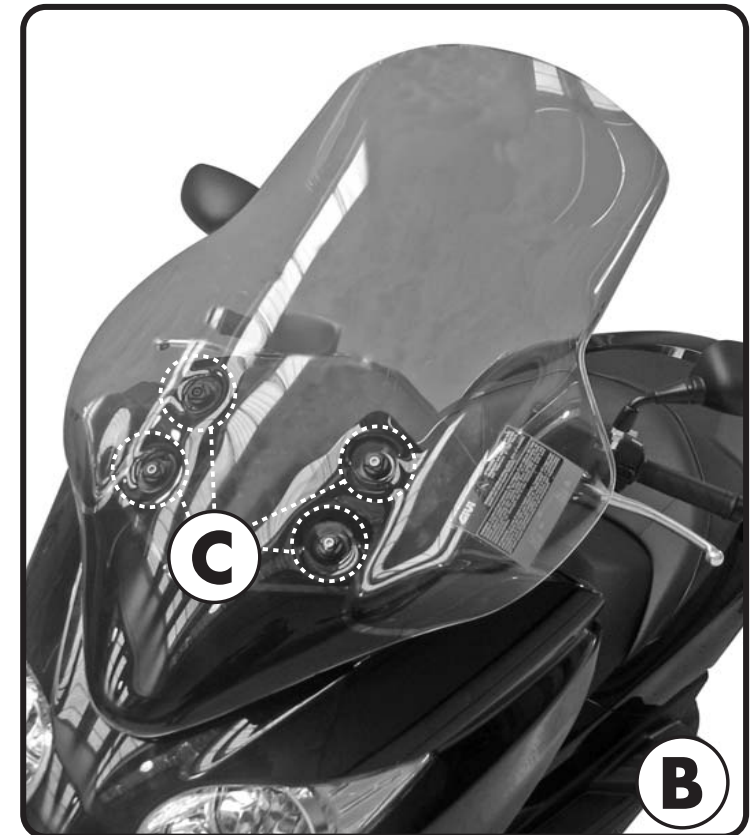

B

ATTACCHI SPECIFICI PER - SPECIFIC FITTING KIT FOR
 KIT DE MONTAGE SPECIFIQUE POUR - SPEZIFISCHER MONTAGEKIT FÜR
 ANCLAJE ESPECÍFICO PARA

HONDA FORZA 250 2008

ISTRUZIONI DI MONTAGGIO - MOUNTING INSTRUCTIONS
 INSTRUCCIONES DE MONTAJE - BAUANLEITUNG - INSTRUCCIONES DE MONTAJE

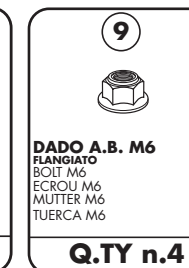
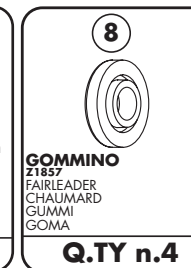
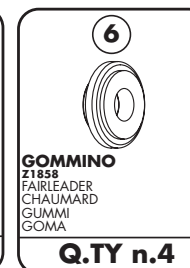
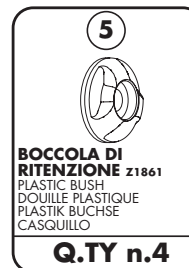
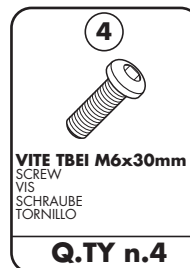
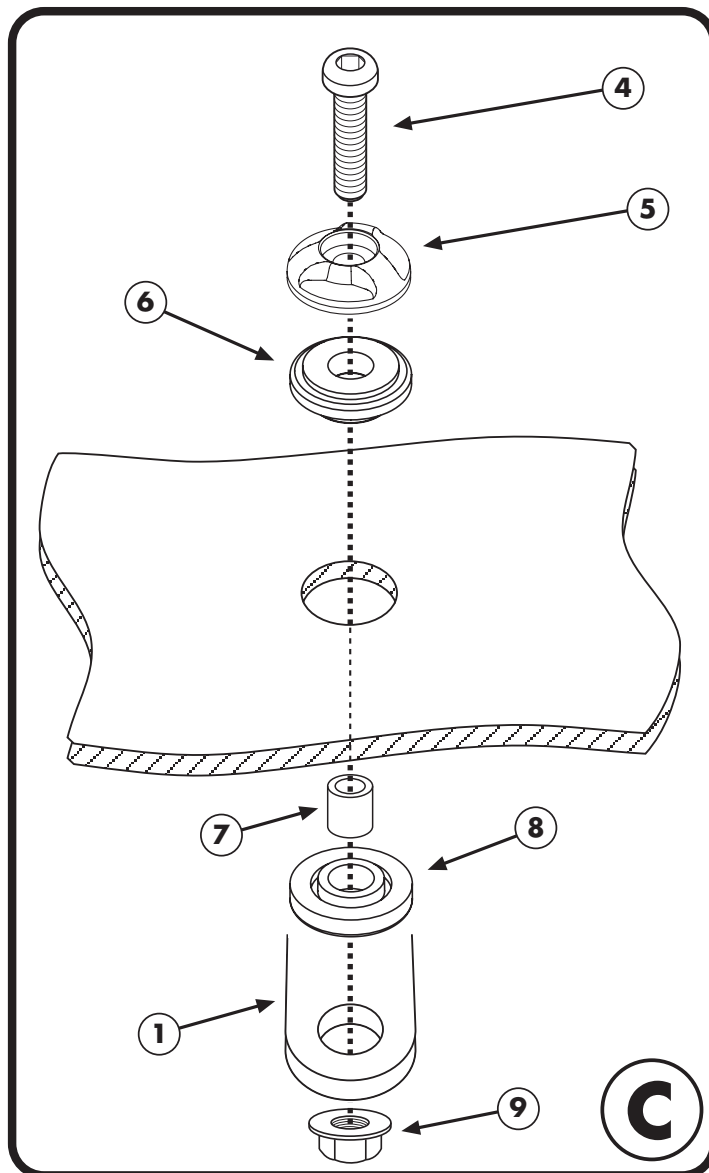

ATTACCHI SPECIFICI PER - SPECIFIC FITTING KIT FOR
KIT DE MONTAGE SPECIFIQUE POUR - SPEZIFISCHER MONTAGEKIT FÜR
ANCLAJE ESPECÍFICO PARA

HONDA FORZA 250 2008

ISTRUZIONI DI MONTAGGIO - MOUNTING INSTRUCTIONS
INSTRUCTIONS DE MONTAGE - BAUANLEITUNG - INSTRUCCIONES DE MONTAJE

I ISTRUZIONI DI MONTAGGIO

1. FISSARE I 2 SUPPORTI N° 1 ALLO SCOOTER COME INDICATO IN FIGURA A;
2. FISSARE IL PARABREZZA AI SUPPORTI N°1 COME INDICATO IN FIGURA B, SEGUENDO IL MONTAGGIO RIPORTATO IN FIGURA C.

GB MOUNTING INSTRUCTIONS

1. INSTALL THE TWO SUPPORTS N°1 TO THE SCOOTER AS SHOWN IN PICTURE A;
2. ATTACH THE WIND-SCREEN TO THE SUPPORTS N°1 AS SHOWN IN PICTURE B, FOLLOWING THE MOUNTING CONFIGURATION SEEN IN PICTURE C.

F INSTRUCTIONS DE MONTAGE

1. FIXER LES DEUX SUPPORTS N°1 AU SCOOTER COMME INDIQUE EN PHOTO A;
2. FIXER LE PARE-BRISE AUX SUPPORTS N°1 COMME INDIQUE EN PHOTO B, EN SUIVANT LE MONTAGE PROPOSE EN PHOTO C.

D BAUANLEITUNG

1. BEFESTIGEN SIE DIE 2 HALTERUNGEN (POSITION NR. 1) AN DEM ROLLER WIE IM BILD A GEZEIGT;
2. BEFESTIGEN SIE DAS WINDSCHILD AN DEN HALTERUNGEN NR. 1 WIE IM BILD B HINGEWIESEN UND FOLGEN SIE DER MONTAGE WIE IM BILD C GEZEIGT.

ES INSTRUCCIONES DE MONTAJE

1. FIJAR LOS DOS SOPORTES AL SCOOTER COMO FIGURA EN LA ILUSTRACIÓN "A"
2. FIJAR EL PARABRISAS A LOS SOPORTES N. 1 COMO MUESTRA LA IMAGEN "B", Y SEGUIR EL MONTAJE SEGÚN LA ILUSTRACIÓN "C".