

PORTAVALIGIE LATERALE SPECIFICO - SPECIFIC TUBULAR SIDE-CASE HOLDER
 PORTE-VALISES LATÉRAUX SPÉCIFIQUE - SPEZIFISCHES STAHLROHR-SEITENTRÄGER
 PORTA MALETAS LATERALES ESPECÍFICO

HONDA VT750s 2010

ISTRUZIONI DI MONTAGGIO - MOUNTING INSTRUCTIONS
 INSTRUCCIONES DE MONTAJE - BAUANLEITUNG - INSTRUCCIONES DE MONTAJE

1



SUPPORTO
SUPPORT
SUPPORT
HALTERUNG
SOPORTE

Q.TY n.2(Dx-Sx)

2

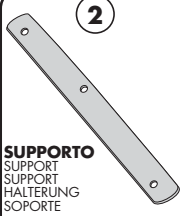

SUPPORTO
SUPPORT
SUPPORT
HALTERUNG
SOPORTE

Q.TY n.1

3



SUPPORTO
SUPPORT
SUPPORT
HALTERUNG
SOPORTE

Q.TY n.2

4



VITE TT M6x25mm
INOX
SCREW
VIS
SCHRAUBE
TORNILLO

Q.TY n.4

5



VITE TT M6x20mm
INOX
SCREW
VIS
SCHRAUBE
TORNILLO

Q.TY n.1

6

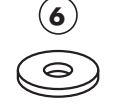

RONDELLA IN GOMMA
foro 6mm
RUBBER WASHER
RONDELLE EN CAOUTCHOUC
GUMMI SCHEIBE
ARANDELA DE GOMA

Q.TY n.5

7



RONDELLA Ø6x18mm
WASHER
RONDELLE
SCHEIBE
ARANDELA

Q.TY n.1

8



RONDELLA INOX
Ø6mm
WASHER
RONDELLE
SCHEIBE
ARANDELA

Q.TY n.8

9



DADO CIECO M6
BOLT
ECROU
MUTTER
TUERCA CIEGA

Q.TY n.5

10



FASCETTA UNIVERSALE
CLAMP
COLLIER
SCHELLE
ABRAZADERA

Q.TY n.2(Dx-Sx)

11



PROTEZIONE ADESIVA
ADHESIVE PROTECTION
PROTECTION ADHESIVE
SCHUTZKLEBER
PROTECCION ADHESIVA

Q.TY n.1

12



PROTEZIONE ADESIVA
ADHESIVE PROTECTION
PROTECTION ADHESIVE
SCHUTZKLEBER
PROTECCION ADHESIVA

Q.TY n.2

13



VITE TBEI M6x50mm
INOX
SCREW
VIS
SCHRAUBE
TORNILLO

Q.TY n.4

14



VITE TBEI M6x40mm
INOX
SCREW
VIS
SCHRAUBE
TORNILLO

Q.TY n.2

15



DADO A.B. RIB. M6
INOX
BOLT M8
ECROU M8
MUTTER M8
TUERCA M8

Q.TY n.6

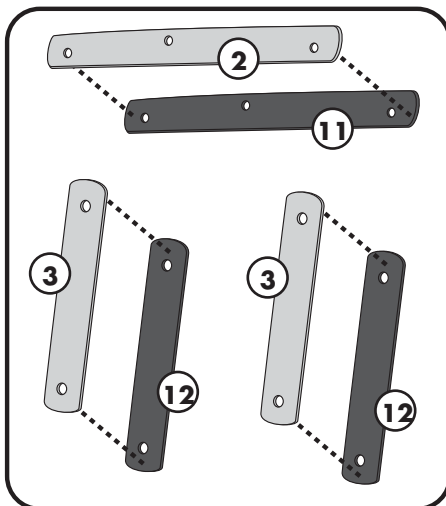
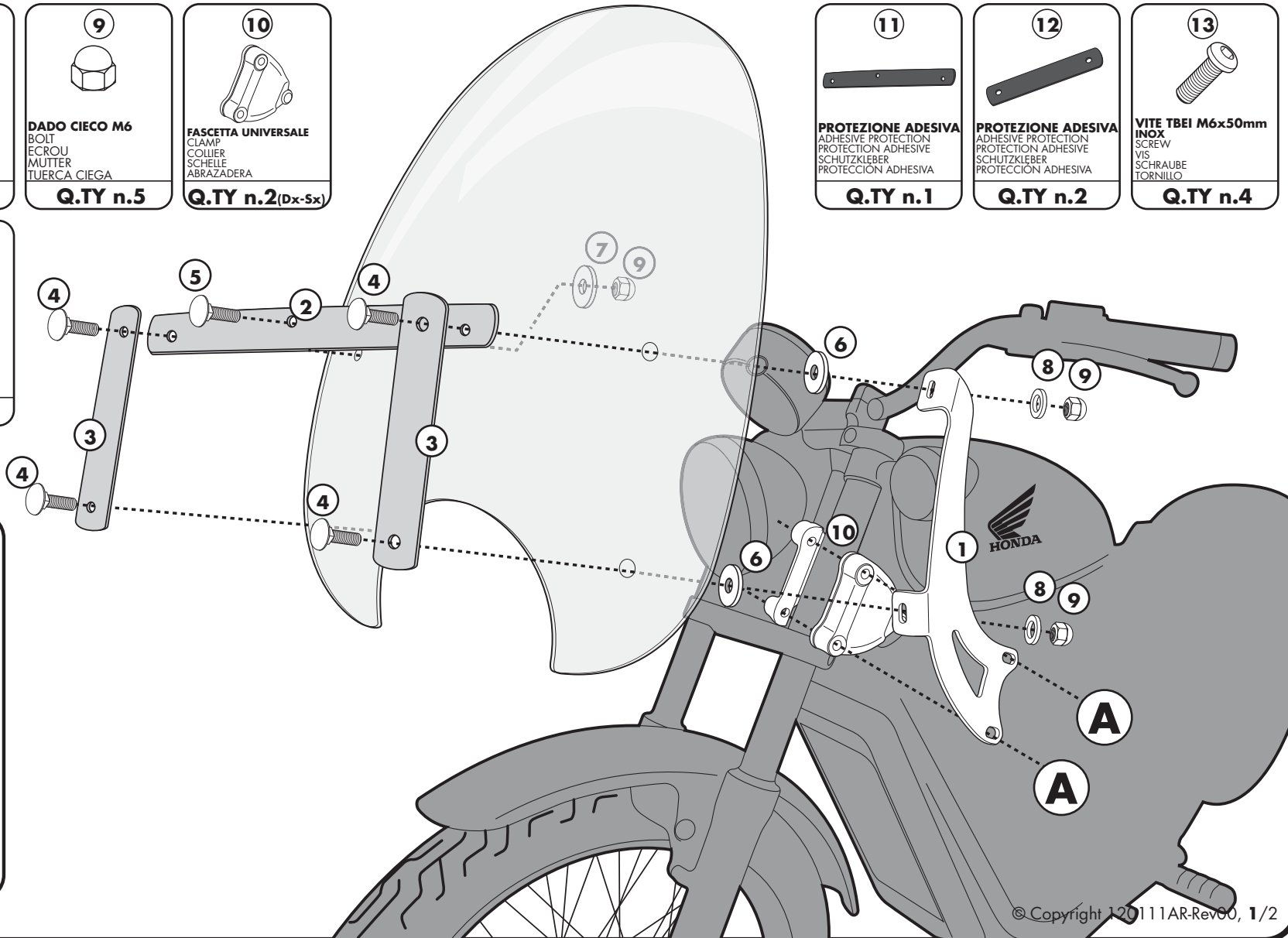

PORTAVALIGIE LATERALE SPECIFICO - SPECIFIC TUBULAR SIDE-CASE HOLDER
PORTE-VAISES LATÉRAUX SPÉCIFIQUE - SPEZIFISCHES STAHLROHR-SEITENTRÄGER
PORTA MALETAS LATERALES ESPECÍFICO

HONDA VT750s 2010

ISTRUZIONI DI MONTAGGIO - MOUNTING INSTRUCTIONS
INSTRUCTIONS DE MONTAGE - BAUANLEITUNG - INSTRUCCIONES DE MONTAJE

