

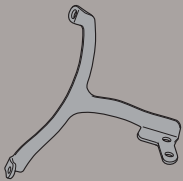











A9100A- A9100A

ATTACCHI SPECIFICI PER - SPECIFIC FITTING KIT FOR - KIT DE MONTAGE SPECIFIQUE POUR - SPEZIFISCHER MONTAGEKIT FÜR - ANCLAJE ESPECÍFICO PARA

KEEWAY Logik 125i - 150i (2013)

N°	Descrizione	Caratteristiche	Codice	Quantità	
1	Supporto - Support - Support Halterung - Soporte			2 (Dx,Sx)	
2	Vite - Screw Vis - Schraube Tornillo	TBEI M6x25	625TBE	4	
3	Vite - Screw Vis - Schraube Tornillo	TE M10x45 passo 1.25 Sx		1	
4	Vite - Screw Vis - Schraube Tornillo	TE M10x45 passo 1.25		1	
5	Dado - Bolt - Ecrou Mutter - Tuerca	Auto Bloccante Flangiato M6	6DADIABFN	4	
6	Dado - Bolt - Ecrou Mutter - Tuerca	Dado auto bloccante passo 1.25	10DADIBS	1	
7	Dado - Bolt - Ecrou Mutter - Tuerca	Dado passo 1.25 Sinistro	V801	1	
8	Rondella - Washer Rondelle - Scheibe Arandela	Ø10	10RON	4	
9	Distanziale - Spacer Entretoise - Distanzstueck - Distanciador	Ø18x25 Foro 10mm	V667	2	
10	Boccola Di Ritenzione - Plastic Bush Douille Plastique - Plastik Buchse Casquillo	-	Z871N	4	
11	Gommino - Fairleader Chaumard - Gummi Goma	-	Z268	4	
12	-	-	-		

A9100A- A9100A

ATTACCHI SPECIFICI PER - SPECIFIC FITTING KIT FOR - KIT DE MONTAGE SPECIFIQUE POUR - SPEZIFISCHER MONTAGEKIT FÜR - ANCLAJE ESPECÍFICO PARA

KEEWAY Logik 125i - 150i (2013)

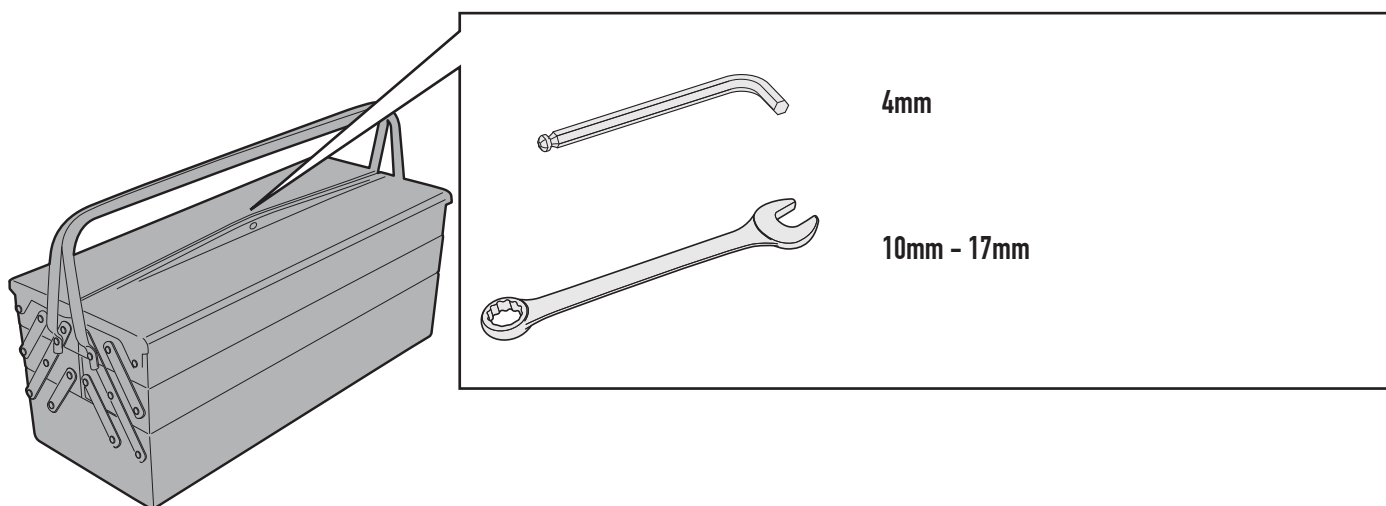

A9100A- A9100A

ATTACCHI SPECIFICI PER - SPECIFIC FITTING KIT FOR - KIT DE MONTAGE SPECIFIQUE POUR - SPEZIFISCHER MONTAGEKIT FÜR - ANCLAJE ESPECÍFICO PARA

KEEWAY Logik 125i - 150i (2013)

