

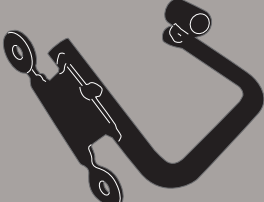





A8701 - KA8701

ATTACCHI SPECIFICI PER - SPECIFIC FITTING KIT FOR - KIT DE MONTAGE SPECIFIQUE POUR
 SPEZIFISCHER MONTAGEKIT FÜR - ANCLAJE ESPECÍFICO PARA - ANCORADOURO ESPECÍFICO

BENELLI BN600R (2014)

N°	Descrizione	Caratteristiche	Codice	Quantità	
1	Supporto - Support - Support Halterung - Soporte - Apoio	-	GNB1259DXS GNB1259SXS	2 (Dx,Sx)	
2	Vite - Screw - Vis Schraube - Tornillo - Parafuso	TCEI M6x45	645TCE	2	
3	Vite - Screw - Vis Schraube - Tornillo - Parafuso	TBEIFN M6x16	616TBEIFN	4	
4	Dado - Bolt - Ecrou Mutter - Tuerca - Porca	Auto Bloccante Flangiato Ribassato M6	6DADIABFN	4	
5	Rondella In Gomma - Rubber Washer Rondelle En Gomme - Gummischeibe Arandela De Goma - Arruela De Borracha	-	ORONG	4	
6	Rondella In Nylon - Nylon Washer Rondelle Original En Nylon - Nylonscheibe Arandela De Nylon - Arruela De Nylon	-	Z1979	4	
7	Coprivite - Screw Cap Cache Vis - Stopsschraube Tapa Tornillo - Boné	-	Z822	2	
8	-	-	1126A	1	

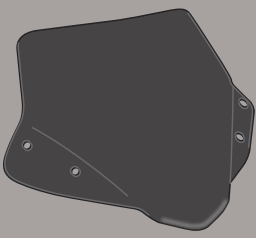
A8701 - KA8701

ATTACCHI SPECIFICI PER - SPECIFIC FITTING KIT FOR - KIT DE MONTAGE SPECIFIQUE POUR
SPEZIFISCHER MONTAGEKIT FÜR - ANCLAJE ESPECÍFICO PARA - ANCORADOURO ESPECÍFICO

BENELLI BN600R (2014)

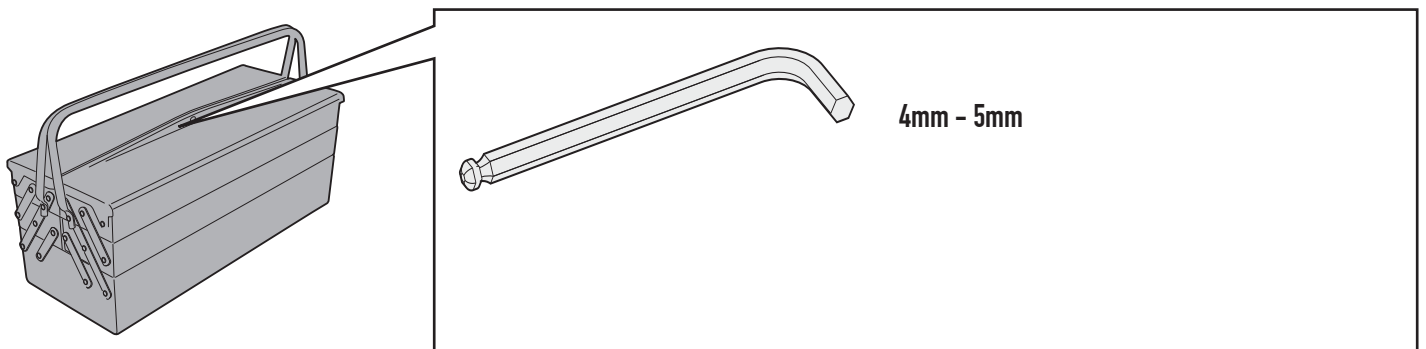

A8701 - KA8701

ATTACCHI SPECIFICI PER - SPECIFIC FITTING KIT FOR - KIT DE MONTAGE SPECIFIQUE POUR
SPEZIFISCHER MONTAGEKIT FÜR - ANCLAJE ESPECÍFICO PARA - ANCORADOURO ESPECÍFICO

BENELLI BN600R (2014)

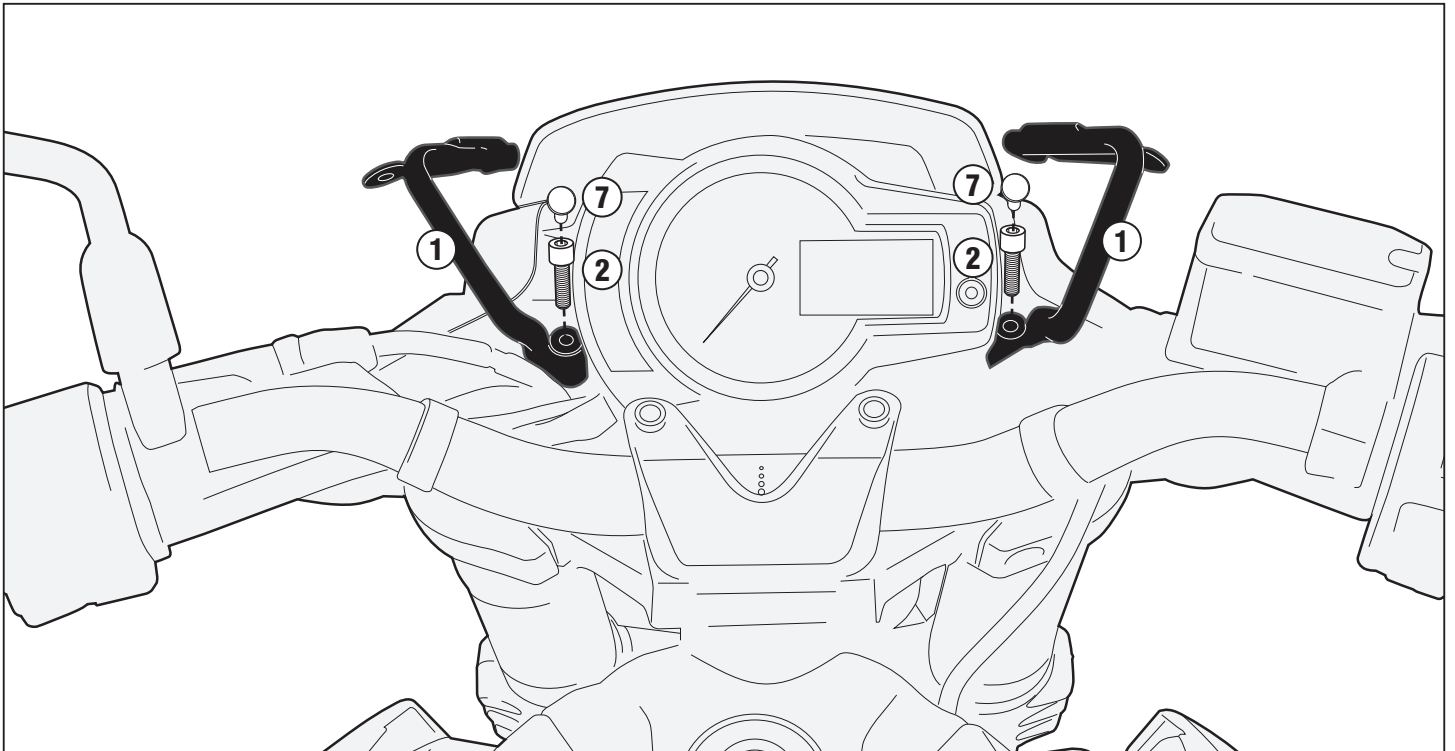
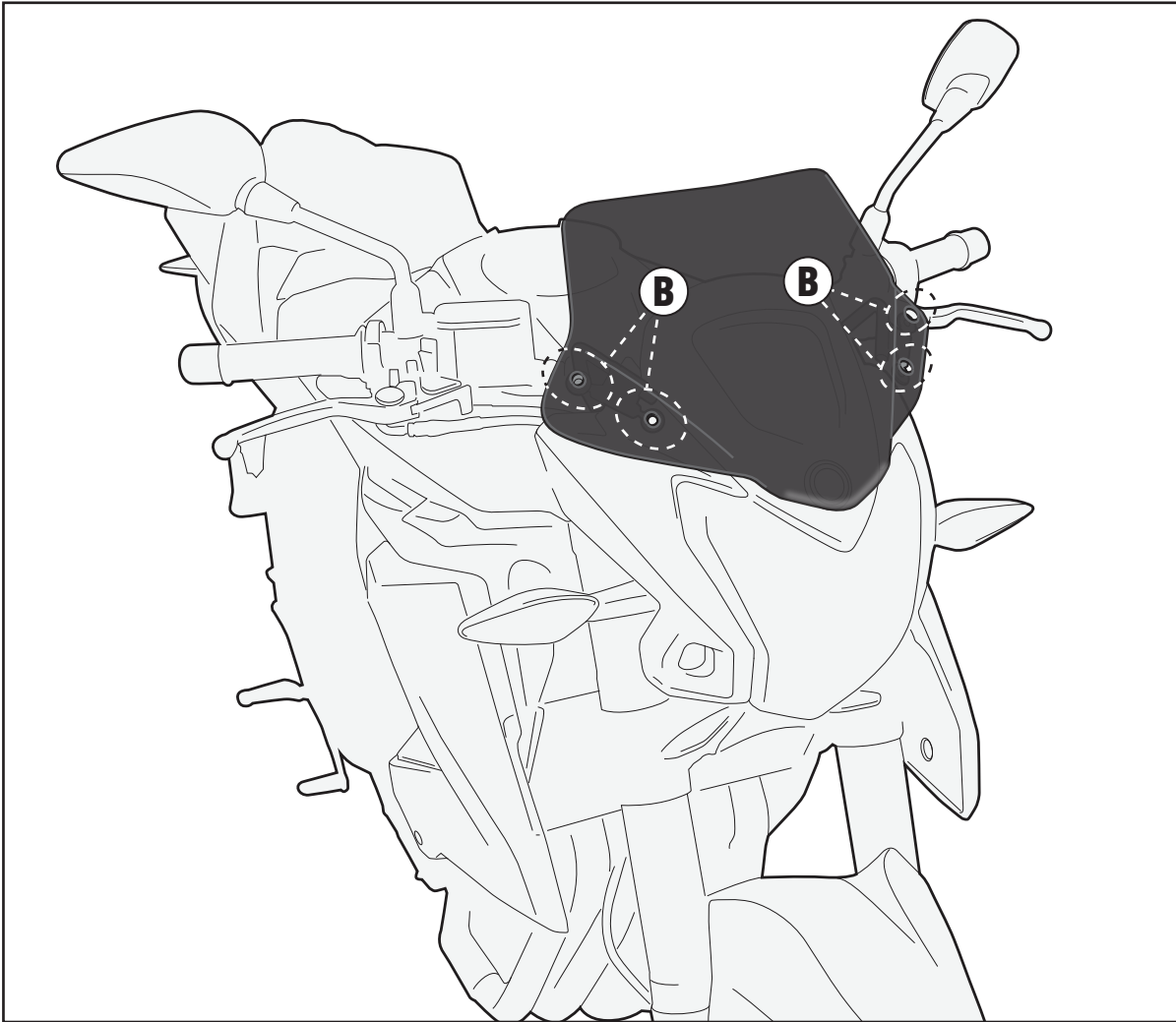

A8701 - KA8701

ATTACCHI SPECIFICI PER - SPECIFIC FITTING KIT FOR - KIT DE MONTAGE SPECIFIQUE POUR
SPEZIFISCHER MONTAGEKIT FÜR - ANCLAJE ESPECÍFICO PARA - ANCORADOURO ESPECÍFICO

BENELLI BN600R (2014)

