

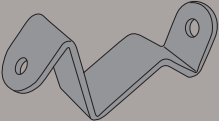





D4111KIT - D4111KIT

ATTACCHI SPECIFICI - SPECIFIC FITTING KIT FOR - KIT DE MONTAGE SPECIFIQUE POUR
 SPEZIFISCHER MONTAGEKIT FÜR - ANCLAJE ESPECÍFICO PARA - ANCHORAGE ESPECÍFICO

KAWASAKI J300 (2013)

N°	Descrizione	Caratteristiche	Codice	Quantità	
1	Supporto - Support - Support Halterung - Soporte - Apoio	Sp. 2 mm	GL2386V	1	
2	Vite - Screw Vis - Schraube Tornillo - Parafuso	TBEI M8x16	816TEF	1	
3	Vite - Screw Vis - Schraube Tornillo - Parafuso	TBEI M6x30	630TBEI	1	
4	Dado - Bolt - Ecrou Mutter - Tuerca - Porca	Dado Auto Bloccante Flangiato M6	6DADIAFLN	1	
5	Boccola Di Ritenzione - Plastic Bush Douille Plastique - Plastik Buchse Casquillo - Concha	-	Z871N	1	
6	Gommino - Fairleader Chaumard - Gummi Goma - Borracha	-	Z268	1	
7	Componenti Originali - Original Parts Parties Originales - Original Bauteile Componentes Originales - Componentes Originais	-	-	-	-
8	-	-	-	-	

D4111KIT - D4111KIT
ATTACCHI SPECIFICI - SPECIFIC FITTING KIT FOR - KIT DE MONTAGE SPECIFIQUE POUR
SPEZIFISCHER MONTAGEKIT FÜR - ANCLAJE ESPECÍFICO PARA - ANCHORAGE ESPECÍFICO
KAWASAKI J300 (2013)

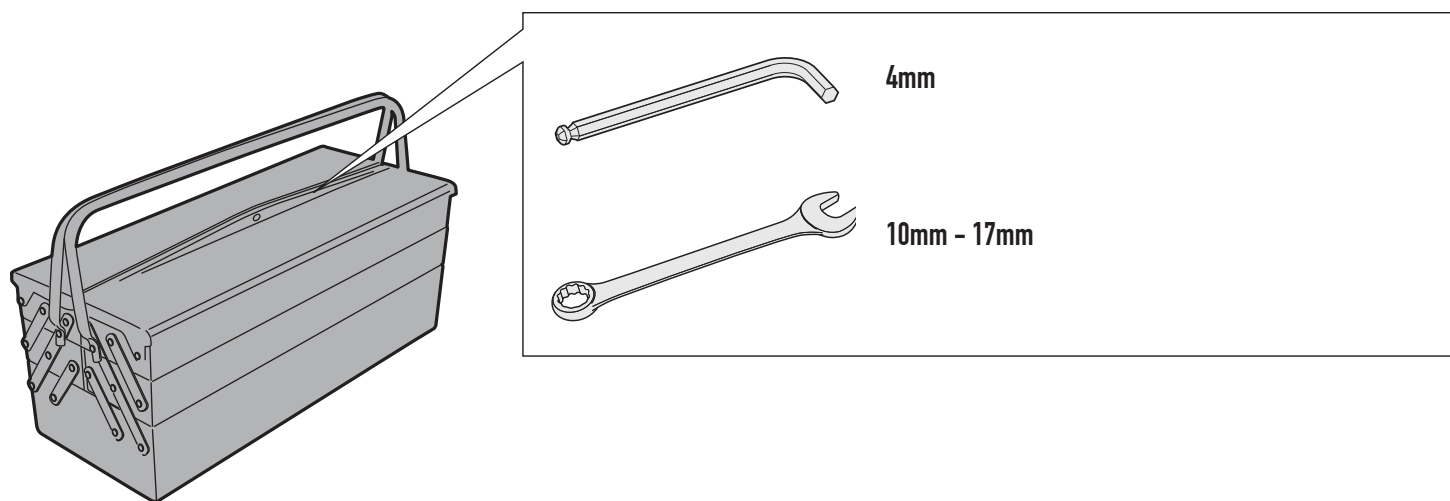

D4111KIT - D4111KIT

ATTACCHI SPECIFICI - SPECIFIC FITTING KIT FOR - KIT DE MONTAGE SPECIFIQUE POUR
SPEZIFISCHER MONTAGEKIT FÜR - ANLAJE ESPECÍFICO PARA - ANCHORAGE ESPECÍFICO

KAWASAKI J300 (2013)

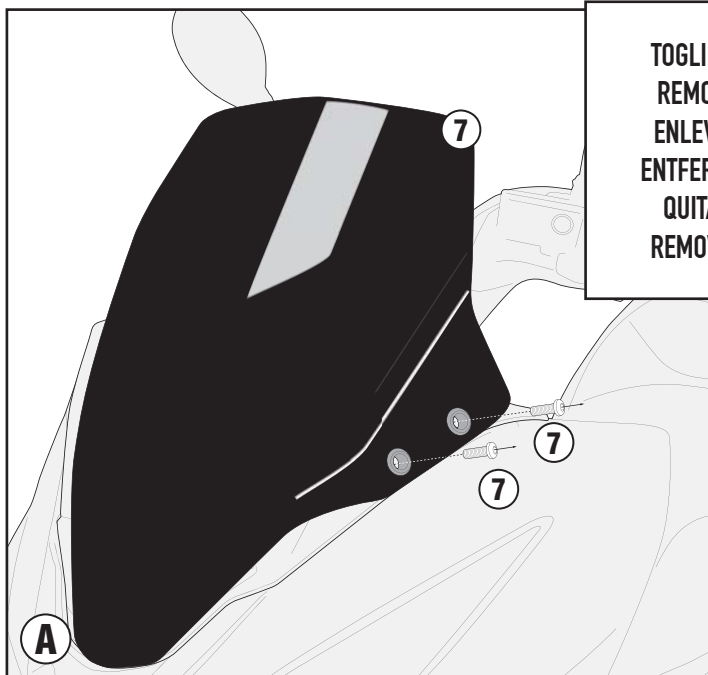

TOGLIERE
REMOVE
ENLEVER
ENTFERNEN
QUITAR
REMOVER

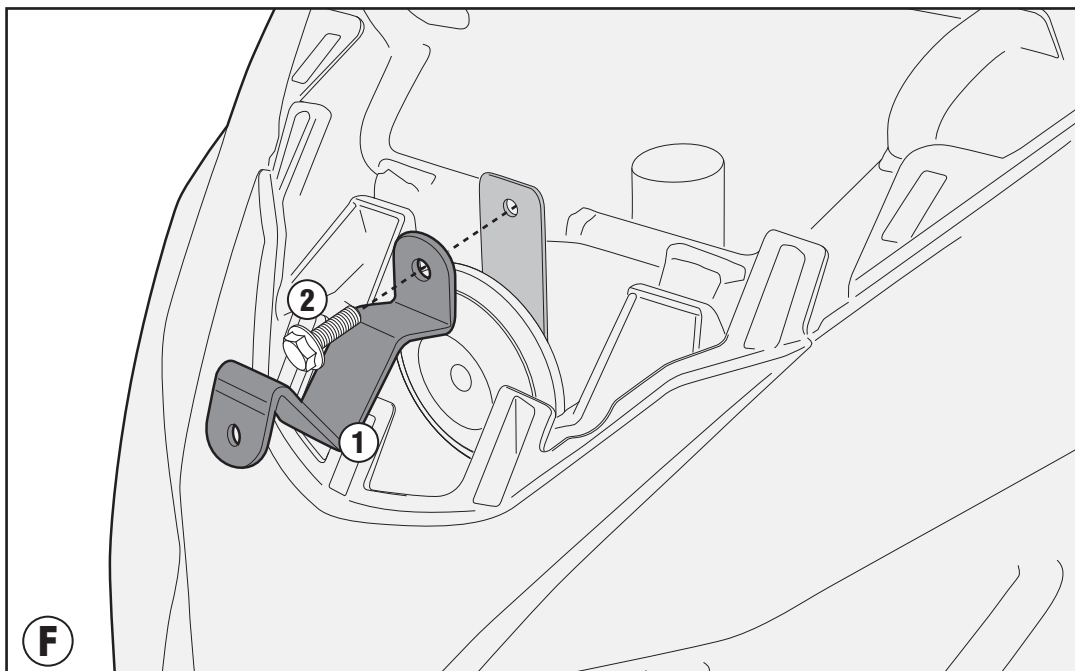
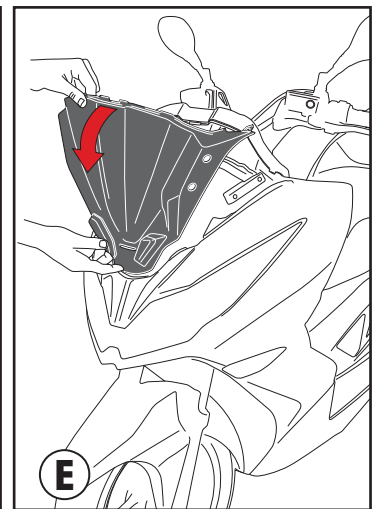
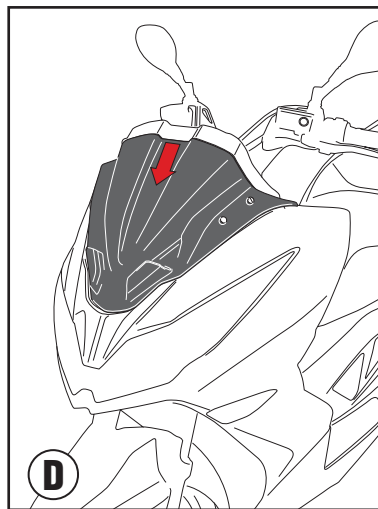
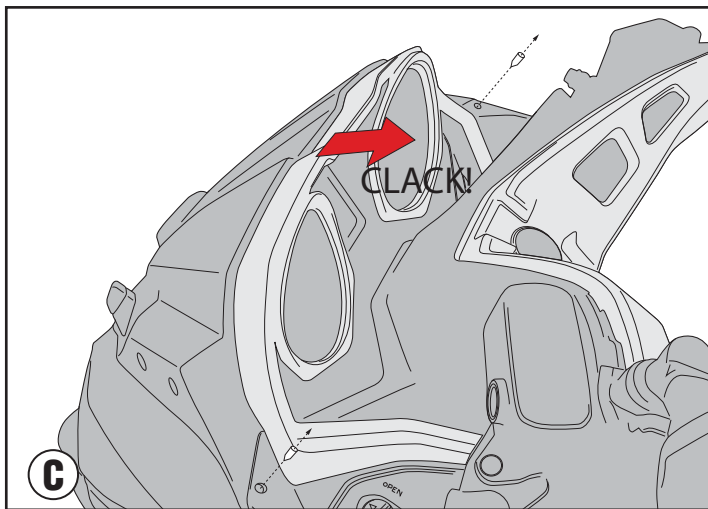
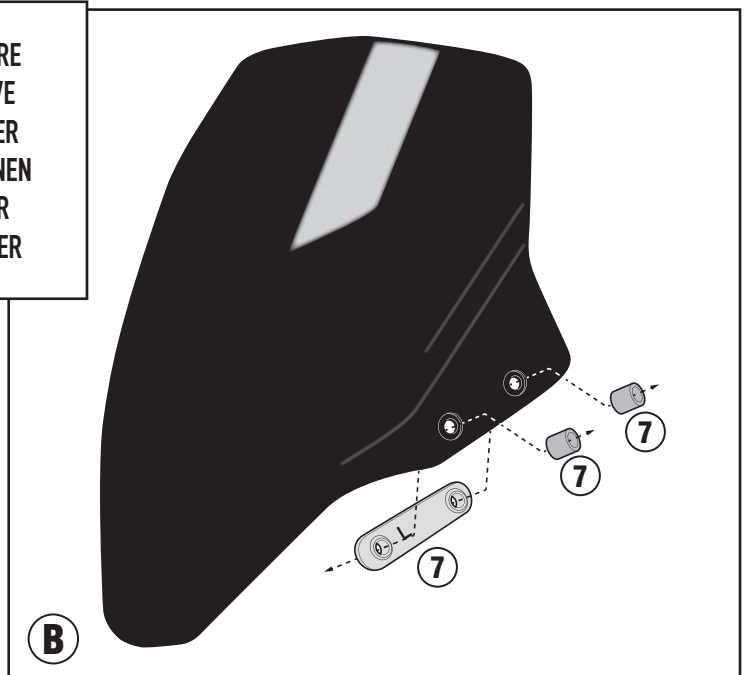

ISTRUZIONI DI MONTAGGIO - MOUNTING INSTRUCTIONS
INSTRUCTIONS DE MONTAGE - BAUANLEITUNG
INSTRUCCIONES DE MONTAJE - INSTRUÇÕES DE MONTAGEM

D4111KIT - D4111KIT

ATTACCHI SPECIFICI - SPECIFIC FITTING KIT FOR - KIT DE MONTAGE SPECIFIQUE POUR
 SPEZIFISCHER MONTAGEKIT FÜR - ANCLAJE ESPECÍFICO PARA - ANCHORAGE ESPECÍFICO

KAWASAKI J300 (2013)

