

# SR1150 - KR1150

PORTAPACCO SPECIFICO - SPECIFIC HOLDER - PORTE-PAQUET SPÉCIFIQUE - SPEZIFISCHER TRÄGER - PORTA-EQUIPAJE ESPECÍFICO

## HONDA INTEGRA 750 (2016)

N°	Descrizione	Caratteristiche	Codice	Quantità
1	Supporto superiore - Support higher - Support supérieur Halterung höher - Soporte superior - Apoio superior	-	GNB1573S	1
2	Supporto inferiore - Lower support - Support inférieur - Soporte inferior - Untere Halterung - Suporte inferior	-	GNB1574S	1
3	Supporto inferiore - Lower support - Support inférieur - Soporte inferior - Untere Halterung - Suporte inferior	-	GL3178S	1
4	Vite - Screw Vis - Schraube Tornillo - Parafuso	TECF M6x30	630TECF	4
5	Vite - Screw Vis - Schraube Tornillo - Parafuso	TBEI M8x35	835TBEI	4
6	Vite - Screw Vis - Schraube Tornillo - Parafuso	TCEI M8x30	830TCEI	4
7	Vite - Screw Vis - Schraube Tornillo - Parafuso	TECF M8x20	820TECF	2
8	Rondella - Washer Rondelle - Scheibe Arandela - Arruela	-	Z1060	4
9	Distanziale - Spacer Entretoise - Distanzstueck Distanciador - Espaçador	Ø14x4 Foro 6,5mm	C14L4F6,5T	4
10	Distanziale - Spacer Entretoise - Distanzstueck Distanciador - Espaçador	Ø14x16 Foro 8,5mm	C14L16F8,5T	4
11	Dado - Bolt - Ecrou Mutter - Tuerca	Dado Autobloccante Flangiato M6	6DADIAFLN	4
12	Dado - Bolt - Ecrou Mutter - Tuerca	Dado Autobloccante Flangiato M8	8DADIAFLN	2
13	Tape	-	Z2412	2
14	Tappo - Cap Fiche - Stecker Enchufe - Boné	-	Z856	2
15	Componenti Originali - Original Parts Parties Originales - Original Bauteile Componentes Originales - Componentes Originais	-	-	-

# SR1150 - KR1150

PORTAPACCO SPECIFICO - SPECIFIC HOLDER - PORTE-PAQUET SPÉCIFIQUE - SPEZIFISCHER TRÄGER - PORTA-EQUIPAJE ESPECÍFICO

## HONDA INTEGRA 750 (2016)

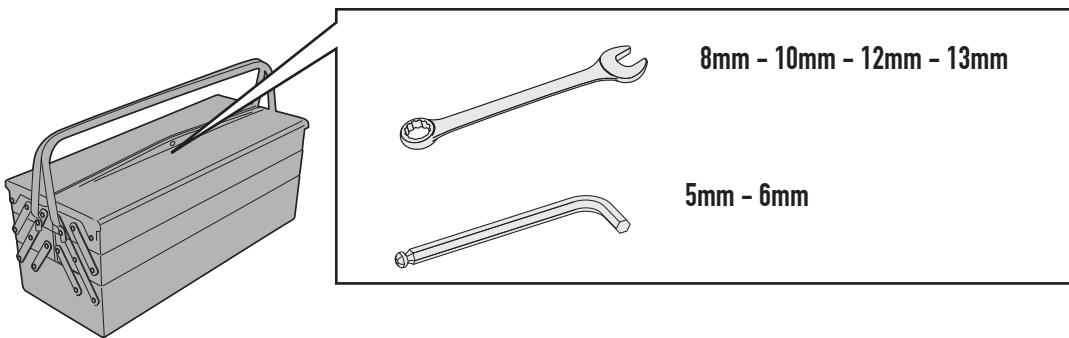
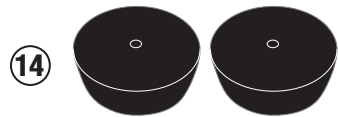
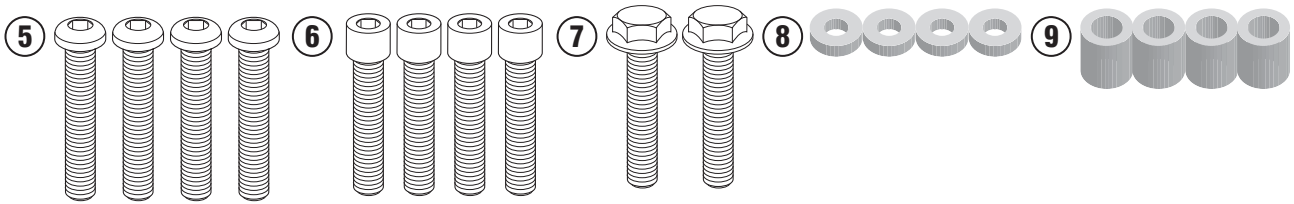
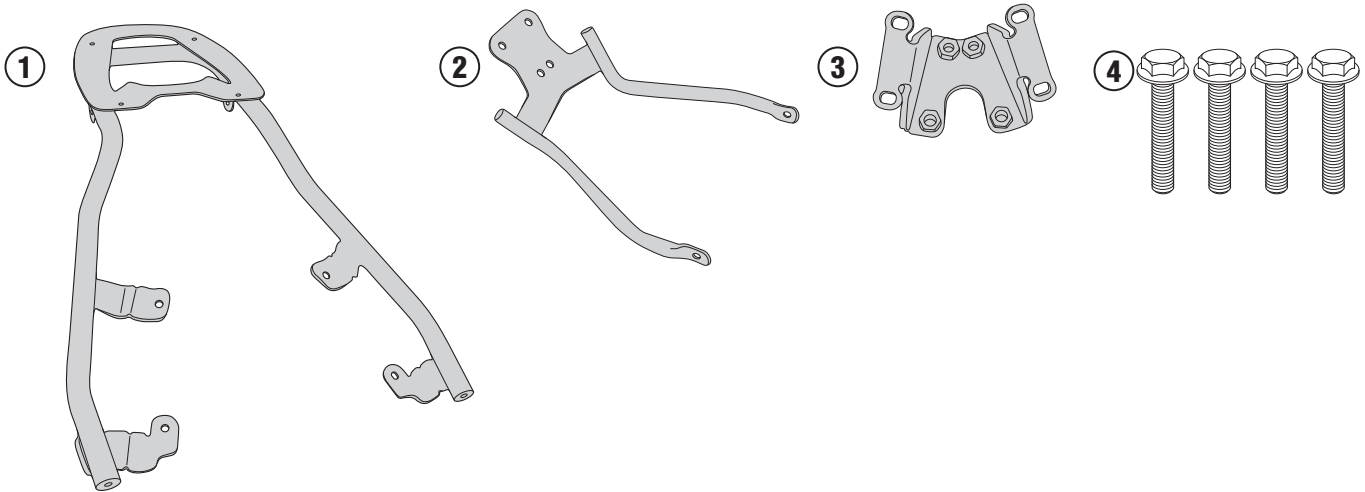

# SR1150 - KR1150

PORTAPACCO SPECIFICO - SPECIFIC HOLDER - PORTE-PAQUET SPÉCIFIQUE - SPEZIFISCHER TRÄGER - PORTA-EQUIPAJE ESPECÍFICO

## HONDA INTEGRA 750 (2016)

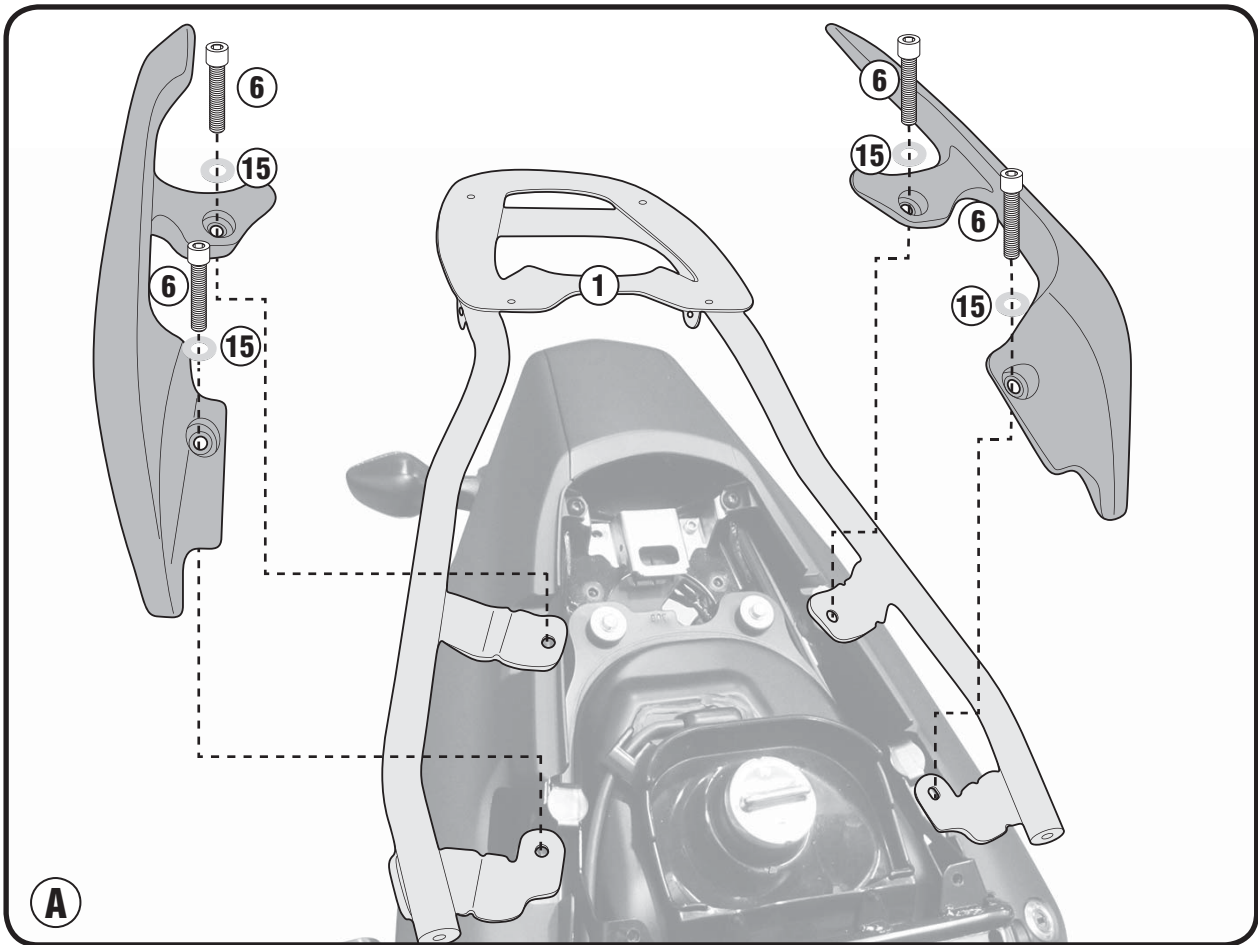
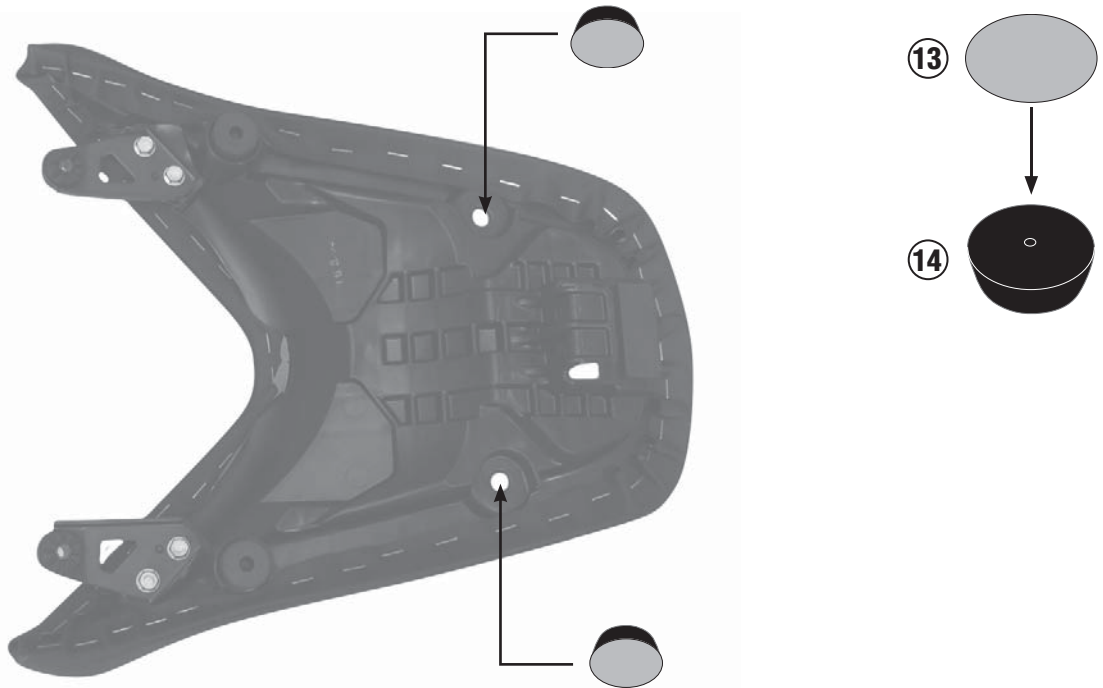

# SR1150 - KR1150

PORTAPACCO SPECIFICO - SPECIFIC HOLDER - PORTE-PAQUET SPÉCIFIQUE - SPEZIFISCHER TRÄGER - PORTA-EQUIPAJE ESPECÍFICO

## HONDA INTEGRA 750 (2016)

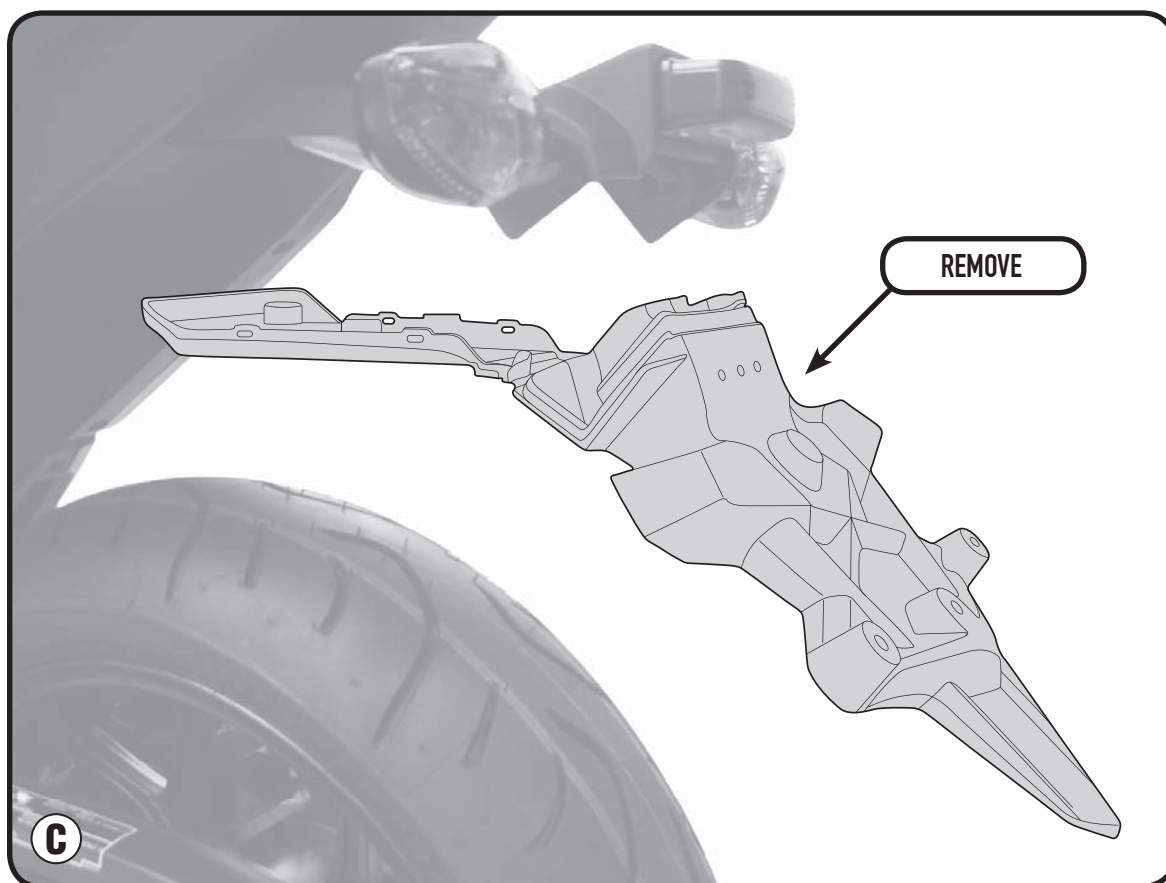
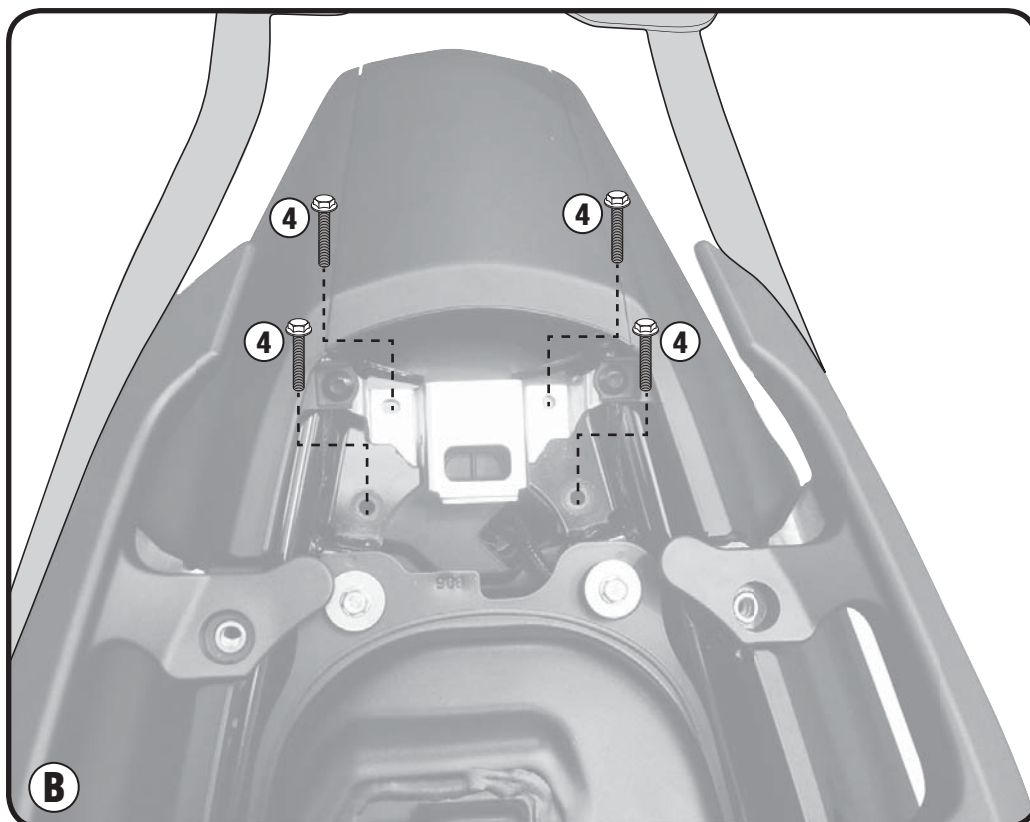

# SR1150 - KR1150

PORTAPACCO SPECIFICO - SPECIFIC HOLDER - PORTE-PAQUET SPÉCIFIQUE - SPEZIFISCHER TRÄGER - PORTA-EQUIPAJE ESPECÍFICO

## HONDA INTEGRA 750 (2016)

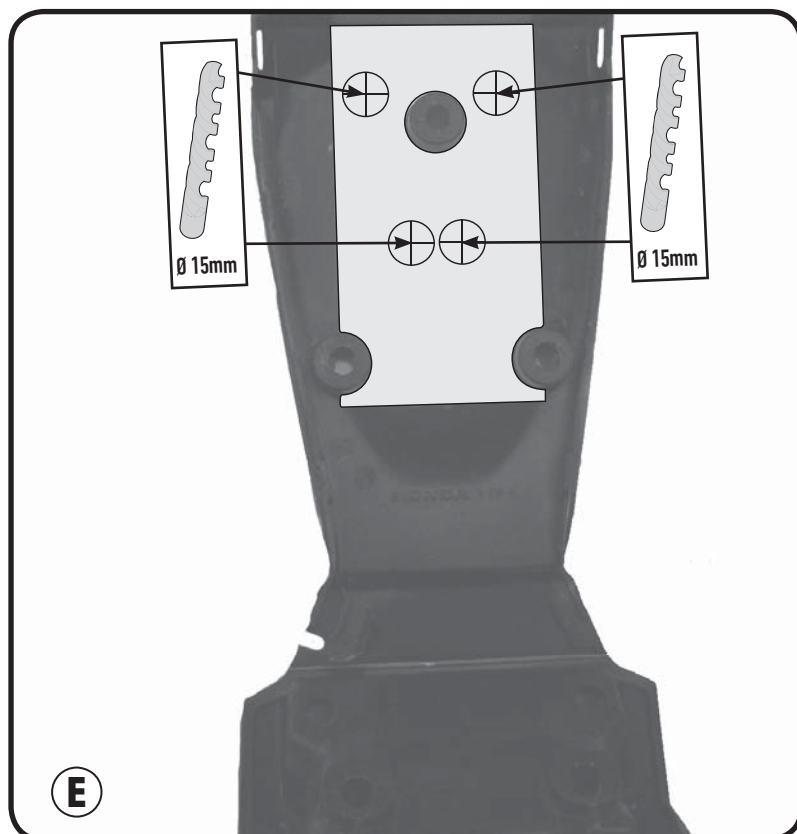
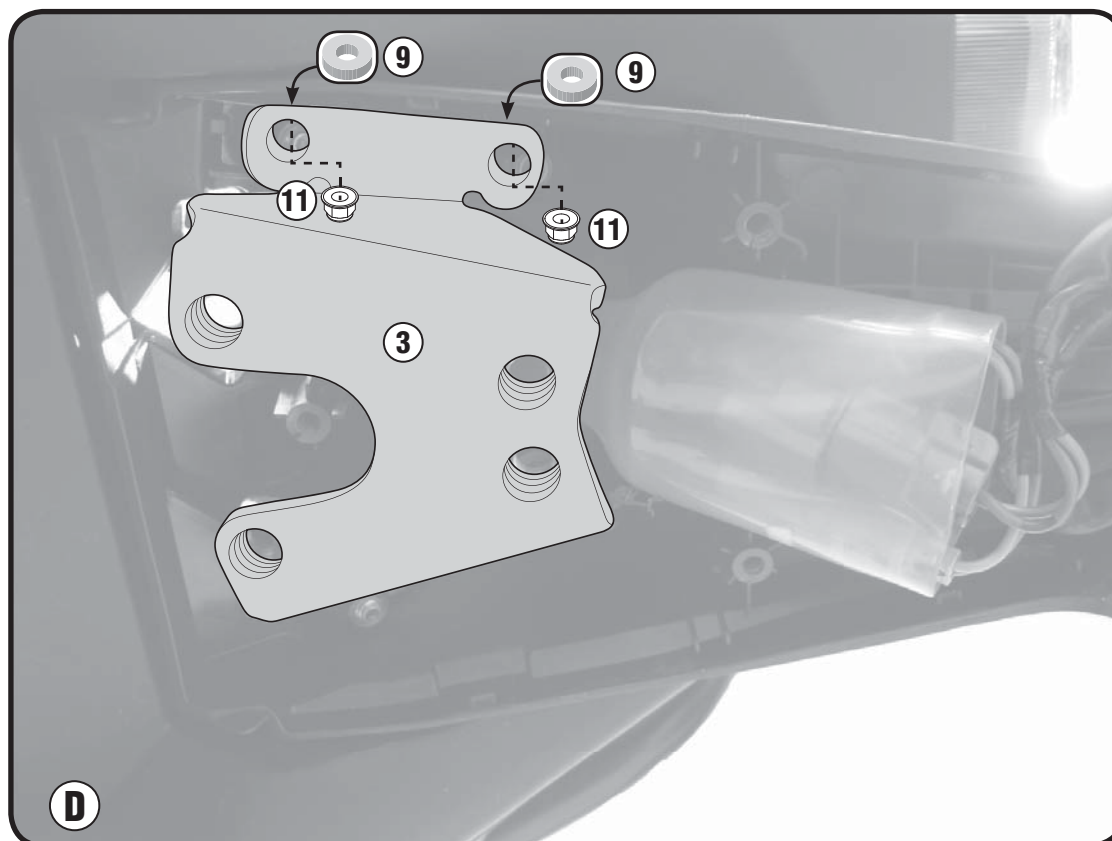

Forare con una punta di piccolo diametro. Allargare il foro fino ad un diametro di 15mm.

Drill it using a small drill bit. Widen the hole to a diameter of 6.5mm.

Bohren dort mit einem dünnen Bohrer durch den Deckel, erweitern Sie die Bohrungen bis zum endgültigen Durchmesser von 15 mm.

Trous et faire un avant-trou. Percer au diamètre de 15mm.

Fure usando uma pequena broca. Alargar o furo para um diâmetro de 15 milímetros.

Perforar con una punta de poco diámetro. Abrir el agujero hasta un diámetro de 15mm.

# SR1150 - KR1150

PORTAPACCO SPECIFICO - SPECIFIC HOLDER - PORTE-PAQUET SPÉCIFIQUE - SPEZIFISCHER TRÄGER - PORTA-EQUIPAJE ESPECÍFICO

## HONDA INTEGRA 750 (2016)

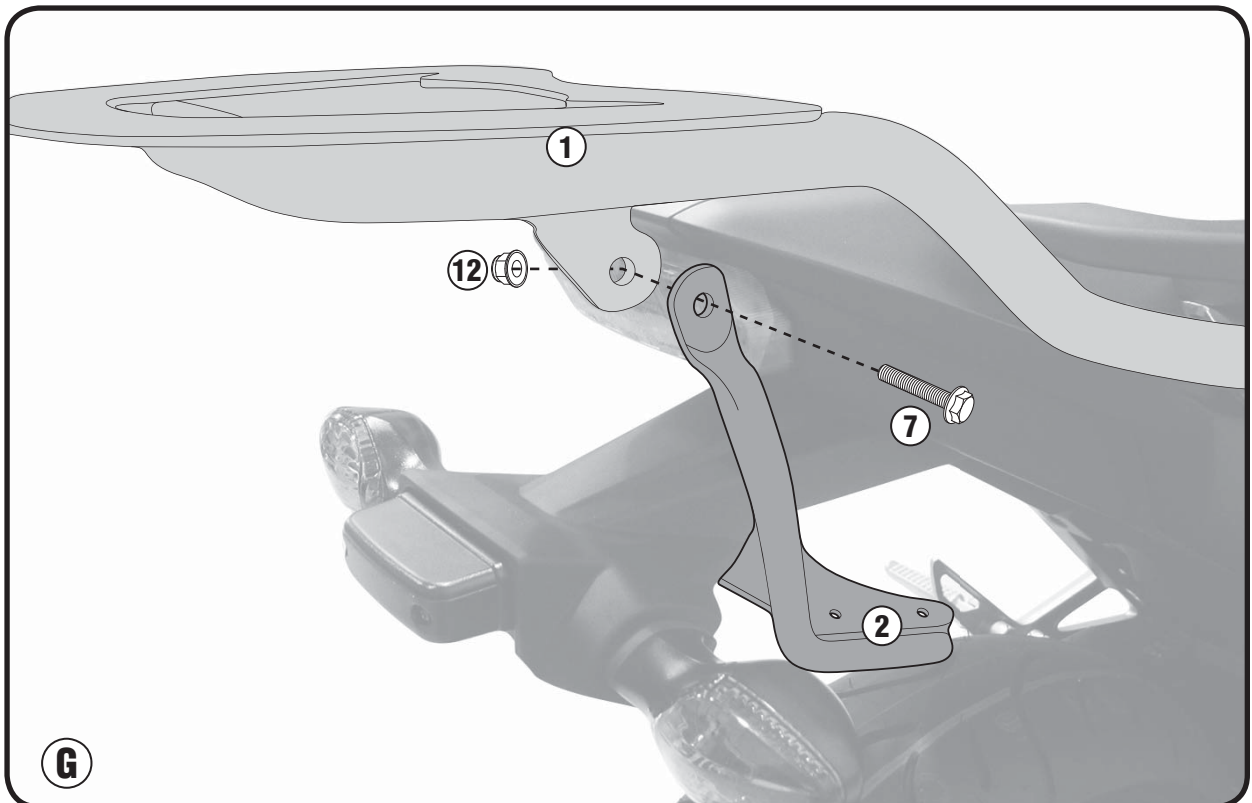

# SR1150 - KR1150

PORTAPACCO SPECIFICO - SPECIFIC HOLDER - PORTE-PAQUET SPÉCIFIQUE - SPEZIFISCHER TRÄGER - PORTA-EQUIPAJE ESPECÍFICO

## HONDA INTEGRA 750 (2016)

---

