

PORTAVALIGIA SPECIFICO - SPECIFIC CASE HOLDER
 PORTE-VALISE SPECIFIQUE - SPEZIFISCHER KOFFER-TRÄGER
 PORTA-EQUIPAJE ESPECIFICO

PIAGGIO X8 2004
125/200cc

ISTRUZIONI DI MONTAGGIO - MOUNTING INSTRUCTIONS
 INSTRUCTIONS DE MONTAGE - BAUANLEITUNG - INSTRUCCIONES DE MONTAJE

1



SUPPORTO PIASTRA
 PLATE SUPPORT
 SUPPORT PLAQUE
 PLATTEHALTERUNG
 SOPORTE PLETINA

Q.TY n.2(Dx-Sx)

2



SUPPORTO
 SUPPORT
 SUPPORT
 HALTERUNG
 SOPORTES

Q.TY n.1

3



RONDELLA Ø8x14
 WASHER Ø8x14
 RONDELLE Ø8x14
 SCHEIBE Ø8x14
 ARANDELA Ø8x14

Q.TY n.2

4



RONDELLA Ø6
 WASHER Ø6
 RONDELLE Ø6
 SCHEIBE Ø6
 ARANDELA Ø6

Q.TY n.6

5



DISTANZIALE
16x6mm foro 6,5
 SPACER
 ENTRETROISE
 DISTANZSTUECK
 DISTANCIADOR

V556

Q.TY n.2

6



TAPPO ANTIFURTO
 ANTI-THEFT CAP
 BOUCHON ANTIVOL
 DIEBSTAHLSICHERUNG
 TAPON ANTIRROBO

Z 872

Q.TY n.1

7



PIASTRA
 PLATE
 PLATINE
 PLETINA

Q.TY n.1

8



VITE TCEI M6x25mm
 SCREW M6x25mm
 VIS M6x25mm
 SCHRAUBE M6x25mm
 TORNILLO M6x25mm

Q.TY n.4

9



DADO A.B. M6
 BOIT M6
 ECROU M6
 MUTTER M6
 TUERCA M6

Q.TY n.4

10 Z126



GOMMINO
 RUBBER
 CAOUTCHOUC
 GUMMI
 GOMA

Q.TY n.4

11



COPRIFORO
 BOIT CAP
 CACHE TROU
 LOCHKAPPE
 TAPA AGUJERO

Z 621

Q.TY n.6

12



VITE TBEI M6x20mm
 SCREW M6x20mm
 VIS M6x20mm
 SCHRAUBE M6x20mm
 TORNILLO M6x20mm

Q.TY n.2

13



VITE TBEI M8x20mm
 SCREW M8x20mm
 VIS M8x20mm
 SCHRAUBE M8x20mm
 TORNILLO M8x20mm

Q.TY n.2

14

COMPONENTI ORIGINALI
 ORIGINAL PARTS
 ORIGINAL BAUTEILE
 PARTIES ORIGINALES
 COMPONENTES ORIGINALES

Q.TY n.-

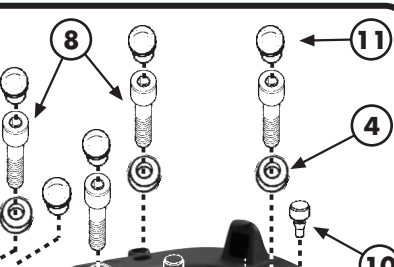

ATTENZIONE: CARICO MASSIMO 6Kg
WARNING: MAX LOAD 13lbs.
ATTENTION: CHARGE MAXIMUM 6Kg.
ACHTUNG: MAX 6Kg.
ATENCION: CARGA MÁXIMA 6 KGS.

15



Z1127DX
Z1127SX

TAPPO
 CAP
 BOUCHON
 KAPPE
 TAPON

Q.TY n.2(Dx-Sx)

16



RONDELLA Ø6x18mm
 WASHER Ø6x18mm
 RONDELLE Ø6x18mm
 SCHEIBE Ø6x18mm
 ARANDELA Ø6x18mm

Q.TY n.4

17



Z298

MOUSSE PROTETTIVA
 PROTECTIVE RUBBER PADS
 MOUSSE DE PROTECTION
 SCHUTZGUMMI
 ESPUMA ADHESIVA
 PROTECTORA

Q.TY n.2

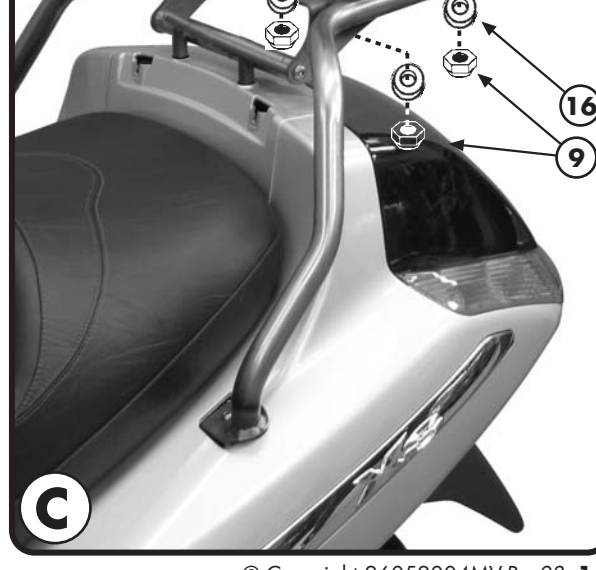
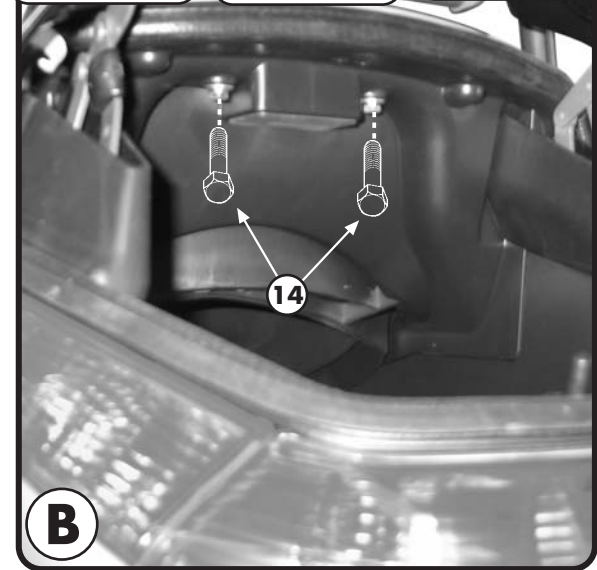
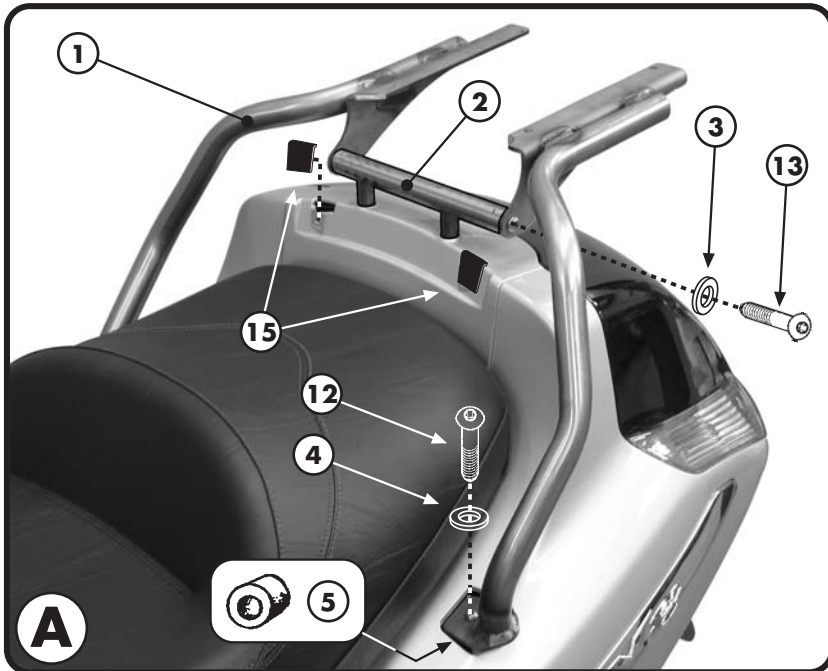

PORTAVALIGIA SPECIFICO - SPECIFIC CASE HOLDER
 PORTE-VALISE SPECIFIQUE - SPEZIFISCHER KOFFER-TRÄGER
 PORTA-EQUIPAJE ESPECIFICO

PIAGGIO X8 2004
 125/200cc

ISTRUZIONI DI MONTAGGIO - MOUNTING INSTRUCTIONS
 INSTRUCTIONS DE MONTAGE - BAUANLEITUNG - INSTRUCCIONES DE MONTAJE

I ISTRUZIONI DI MONTAGGIO

1. SMONTARE IL MANIGLIONE ORIGINALE;
2. MONTARE I PARTICOLARI N°1 E N°2 FISSANDO QUEST'ULTIMO CON I PARTICOLARI N°13 DI FOTO B;
3. FISSARE I TAPPINI N°15 NEI PUNTI INDICATI IN FOTO A;
4. MONTARE LA PISTRA COME INDICATO IN FOTO C.

ATTENZIONE: le protezioni adesive (particolare n°17) sono da utilizzare per proteggere lo sportello posteriore in fase di apertura

GB MOUNTING INSTRUCTIONS

1. REMOVE THE ORIGINAL GRAB HANDLE;
2. MOUNT THE PARTS N° 1 AND 2 FIXING THE LATTER WITH THE PARTS N° 14 IN PICTURE B
3. FIX THE CAPS N° 15 IN THE POINTS INDICATED IN PICTURE A
4. LASTLY MOUNT THE PLATE AS SHOWN IN PICTURE C.

ATTENTION: the protective rubber pads (part n° 17) should be used to protect the door of the rear boot when you open it.

F INSTRUCTIONS DE MONTAGE

1. ENLEVER LA POIGNEE D'ORIGINE
2. METTRE LES PIECES N°1 ET N°2, PUIS FIXER LE TOUT AVEC LES VIS N°14 (PHOTO B)
3. METTRE LES BOUCHONS N°15 (PHOTO A)
4. MONTER LA PLATINE COMME INDIQUE PHOTO C

ATTENTION: les protections adhesives (n°17) doivent etre utilise es pour proteger le capot arriere en position ouverte

D BAUANLEITUNG

1. MONTIEREN SIE DEN ORIGINALHANDGRIFF AB.
2. MONTIEREN SIE DIE TEILE NR. 1 UND 2, BEFESTIGEN SIE DAS TEIL NR. 2 MIT DEM TEIL NR. 14 VOM BILD B
3. BEFESTIGEN SIE DIE KAPPE NR. 15 AUF DIE IM BILD A ANGEZEIGTEN PUNKTEN
4. ZULETZT MONTIEREN SIE DIE PLATTE WIE IM BILD C BESCHRIEBEN

ACHTUNG: verwenden Sie die Schutzgummis (Teil Nr. 17) um die Abdeckung des hinteren Staufachs beim Öffnen zu schützen.

ES

INSTRUCCIONES DE MONTAJE

1. DESMONTAR EL MANILLAR ORIGINAL;
2. MONTAR LOS SOPORTES N° 1 Y N° 2; ESTE ÚLTIMO TENDRÁ QUE ESTAR FIJADO POR LOS TORNILLOS ORIGINALES N° 14 COMO INDICA LA FOTO B;
3. FIJAR LOS TAPONES N° 15 COMO INDICA LA FOTO A;
4. MONTAR LA PARRILLA N° 7 COMO INDICA LA FOTO C

¡ATENCIÓN! las gomas protectoras adhesivas (detalle n° 17) se utilizan para proteger la ventanilla trasera durante la apertura