

PL06415N - KL6415N

PORTAVALIGIE LATERALE SPECIFICO - SPECIFIC TUBULAR SIDE-CASE HOLDER - PORTE-VALISES LATÉRAUX SPÉCIFIQUE
SPEZIFISCHES STAHLROHR-SEITENTRAEGER - PORTA MALETAS LATERALES ESPECÍFICO - SUORTE DE MALAS ESPECÍFICO

TRIUMPH TIGER 900 (2020)

N°	Descrizione/Description	Caratteristiche/Features	Codice/Code	Quantità/Quantity
1	Telaio laterale - Side frame - Châssis latéral - Soporte lateral - Seitenrahmen - Suporte lateral	-	PL06415DXV PL06415SXV	2 (Right: Left)
2	Supporto inferiore - Lower support - Support inférieur Soporte inferior - Untere Halterung - Suporte inferior	-	GL4469DXV GL4469SXV	2 (Right: Left)
3	Ponte Posteriore - Rear Bridge - Pont Postérieure Verbindungsrohr - Puente Trasero	-	GL4470V	1
4	Vite - Screw - Vis - Schraube Tornillo - Parafuso	TBEI M8x45	845TBEI	2
5	Vite - Screw - Vis - Schraube Tornillo - Parafuso	TBEI M8x55	855TBEI	2
6	Vite - Screw - Vis - Schraube Tornillo - Parafuso	TECF M8x20	820TECF	4
7	Vite - Screw - Vis - Schraube Tornillo - Parafuso	TCE M8x120	8120TCE	2
8	Vite - Screw - Vis - Schraube Tornillo - Parafuso	TCE M8x100	8100TCE	2
9	Vite - Screw - Vis - Schraube Tornillo - Parafuso	TBEIFN M6x20	620TBEIFN	2
10	Vite - Screw - Vis - Schraube Tornillo - Parafuso	TBEIFN M6x16	616TBEIFN	1
11	Vite - Screw - Vis - Schraube Tornillo - Parafuso	TBEI M8x65	865TBEI	2
12	Vite - Screw - Vis - Schraube Tornillo - Parafuso	TBEI M8x90	890TBEI	2
13	Rondella - Washer - Rondelle - Scheibe Arandela - Arruela	Foro Ø8mm	8RON	4
14	Rondella - Washer - Rondelle - Scheibe Arandela - Arruela	Foro Ø6mm Esterno Ø20mm Sp. 1,5mm	620RON	2
15	Rondella - Washer - Rondelle - Scheibe Arandela - Arruela	Foro Ø8,5mm Esterno Ø20mm Sp. 2mm	820RON	6
16	Rondella - Washer - Rondelle - Scheibe Arandela - Arruela	Foro Ø6mm	6RON	1
17	Distanziale - Spacer - Entretoise - Distanzstueck Distanciador - Espaçador	Ø18x10 Foro 8,5mm	C18L10F8,5T	2
18	Distanziale - Spacer - Entretoise - Distanzstueck Distanciador - Espaçador	Ø18x22 Foro 8,5mm	C18L22F8,5T	2
19	Boccola - Mounting bush - Entretoise de montage Cilindro de fijación - Montagehülse - Bucha de fixação	-	Z4039	4
20	Dado - Bolt - Ecrou Mutter - Tuerca - Porca	Autobloccante Flangiato M8 (H 9,5mm)	8DADIFN	8
21	Dado - Bolt - Ecrou Mutter - Tuerca - Porca	Autobloccante Flangiato M6 (H 7mm)	6DADIABFN	3
22	Componenti Originali - Original Parts Parties Originales - Original Bauteile Componentes Originales - Componentes Originais	-	-	-
23	Particolari Inclusi nel 01RKIT Components Included In The 01RKIT Pièces Inclues Dans 01RKIT Die Einzelnen Teile Sind Bei 01RKIT Despieces Incluidos 01RKIT Componentes inclusos na 01RKIT	-	-	-

PL06415N - KL6415N

PORTAVALIGIE LATERALE SPECIFICO - SPECIFIC TUBULAR SIDE-CASE HOLDER - PORTE-VALISES LATÉRAUX SPÉCIFIQUE
 SPEZIFISCHES STAHLROHR-SEITENTRAEGER - PORTA MALETAS LATERALES ESPECÍFICO - SUPORTE DE MALAS ESPECÍFICO

TRIUMPH TIGER 900 (2020)

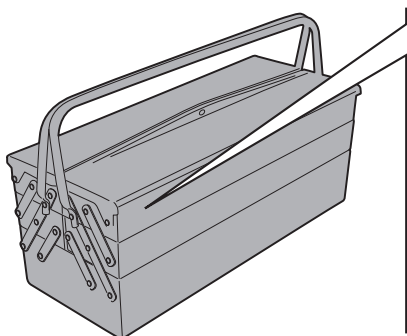
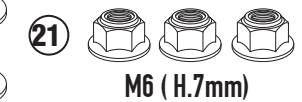
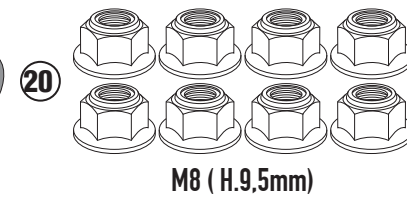
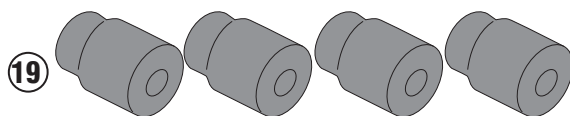
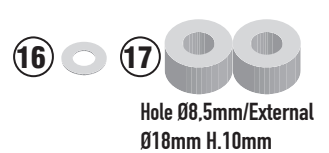
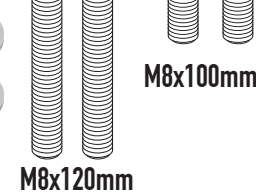
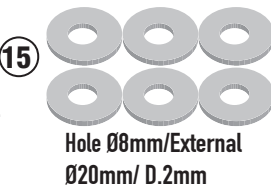
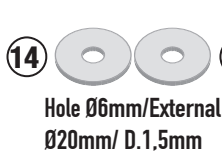
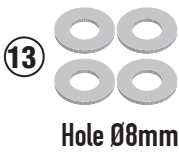
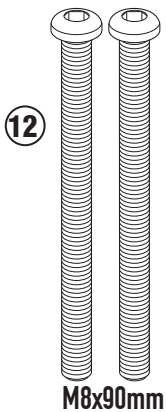
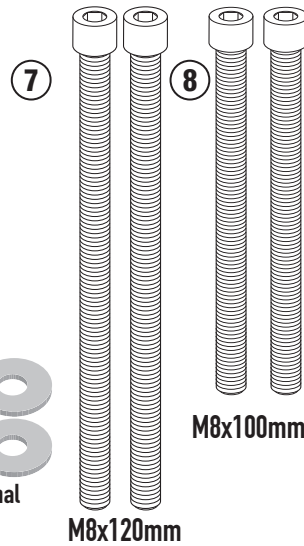
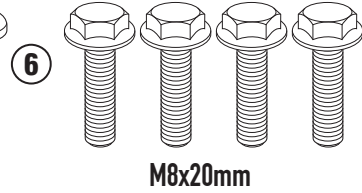
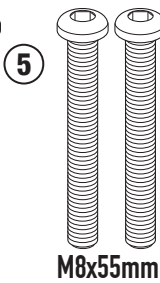
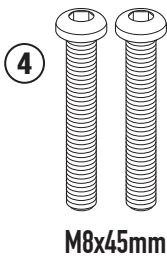
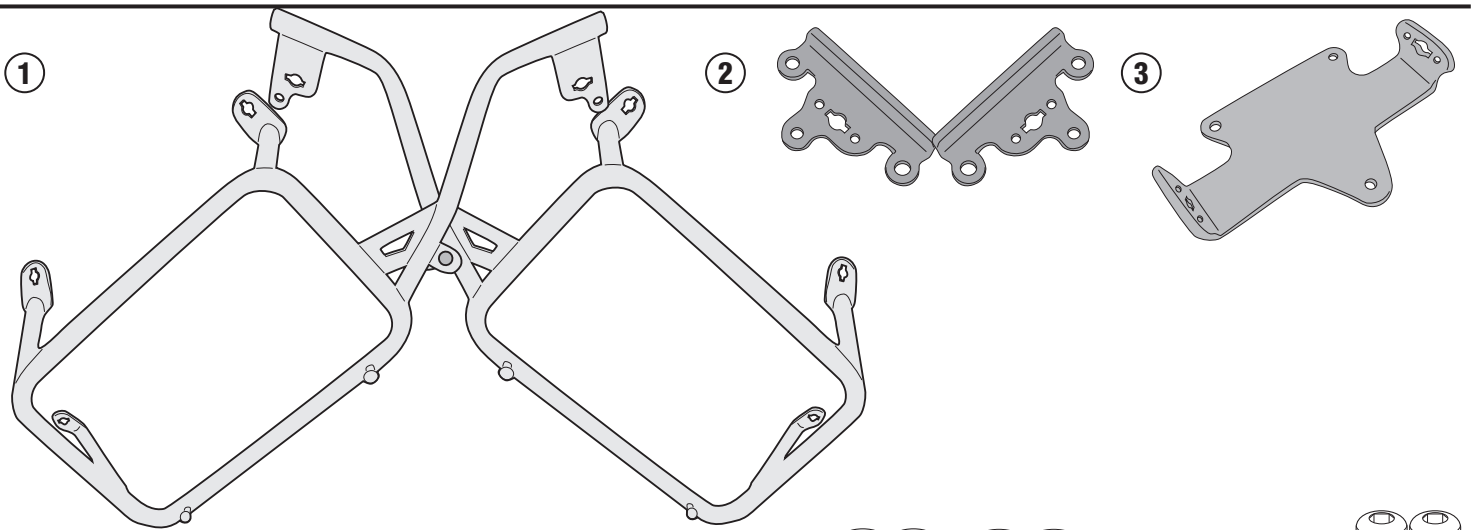

ISTRUZIONI DI MONTAGGIO - MOUNTING INSTRUCTIONS
 INSTRUCTIONS DE MONTAGE - BAUANLEITUNG
 INSTRUCCIONES DE MONTAJE - INSTRUÇÕES DE MONTAGEM

PL06415N - KL6415N

PORTAVALIGIE LATERALE SPECIFICO - SPECIFIC TUBULAR SIDE-CASE HOLDER - PORTE-VALISES LATÉRAUX SPÉCIFIQUE
SPEZIFISCHES STAHLROHR-SEITENTRAEGER - PORTA MALETAS LATERALES ESPECÍFICO - SUPORTE DE MALAS ESPECÍFICO

TRIUMPH TIGER 900 (2020)



- Da abbinare al kit OFMK per l'utilizzo di valigie Monokey o al kit OFCAM per l'utilizzo di valigie MONOKEY® CAM-SIDE Trekker Outback
- To be combined with OFMK kit for Monokey cases or OFCAM kit for Trekker Outback MONOKEY® CAM-SIDE
- À combiner avec le kit OFMK pour valises MONOKEY® ou le kit OFCAM pour Trekker Outback MONOKEY® CAM-SIDE
- Zu montieren mit kit OFMK für MONOKEY® Koffer oder kit OFCAM für Trekker Outback MONOKEY® CAM-SIDE
- A combinar con el kit OFMK para maletas MONOKEY® o el kit OFCAM para Trekker Outback MONOKEY® CAM-SIDE
- Para ser combinado com o kit OFMK para malas MONOKEY® ou o kit OFCAM para Trekker Outback MONOKEY® CAM-SIDE

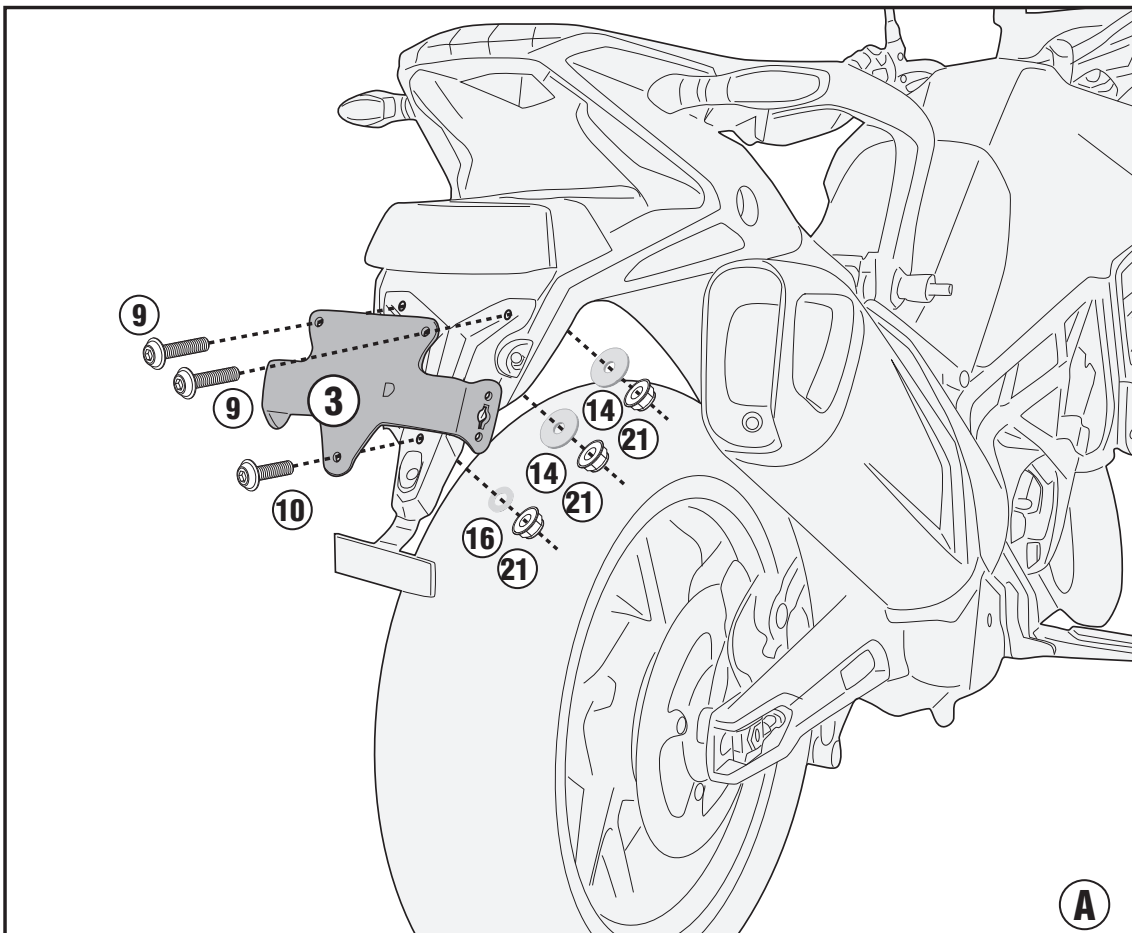
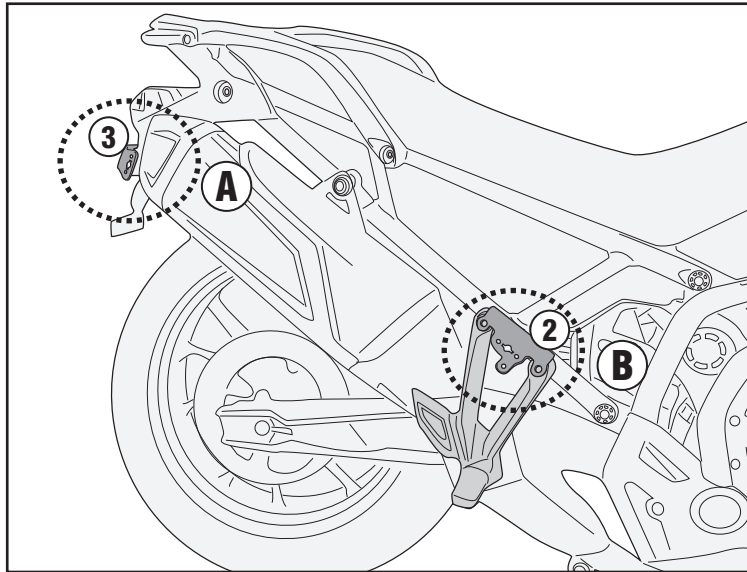

ISTRUZIONI DI MONTAGGIO - MOUNTING INSTRUCTIONS
INSTRUCTIONS DE MONTAGE - BAUANLEITUNG
INSTRUCCIONES DE MONTAJE - INSTRUÇÕES DE MONTAGEM

PL06415N - KL6415N

PORTAVALIGIE LATERALE SPECIFICO - SPECIFIC TUBULAR SIDE-CASE HOLDER - PORTE-VALISES LATÉRAUX SPÉCIFIQUE
SPEZIFISCHES STAHLROHR-SEITENTRAEGER - PORTA MALETAS LATERALES ESPECÍFICO - SUPORTE DE MALAS ESPECÍFICO

TRIUMPH TIGER 900 (2020)

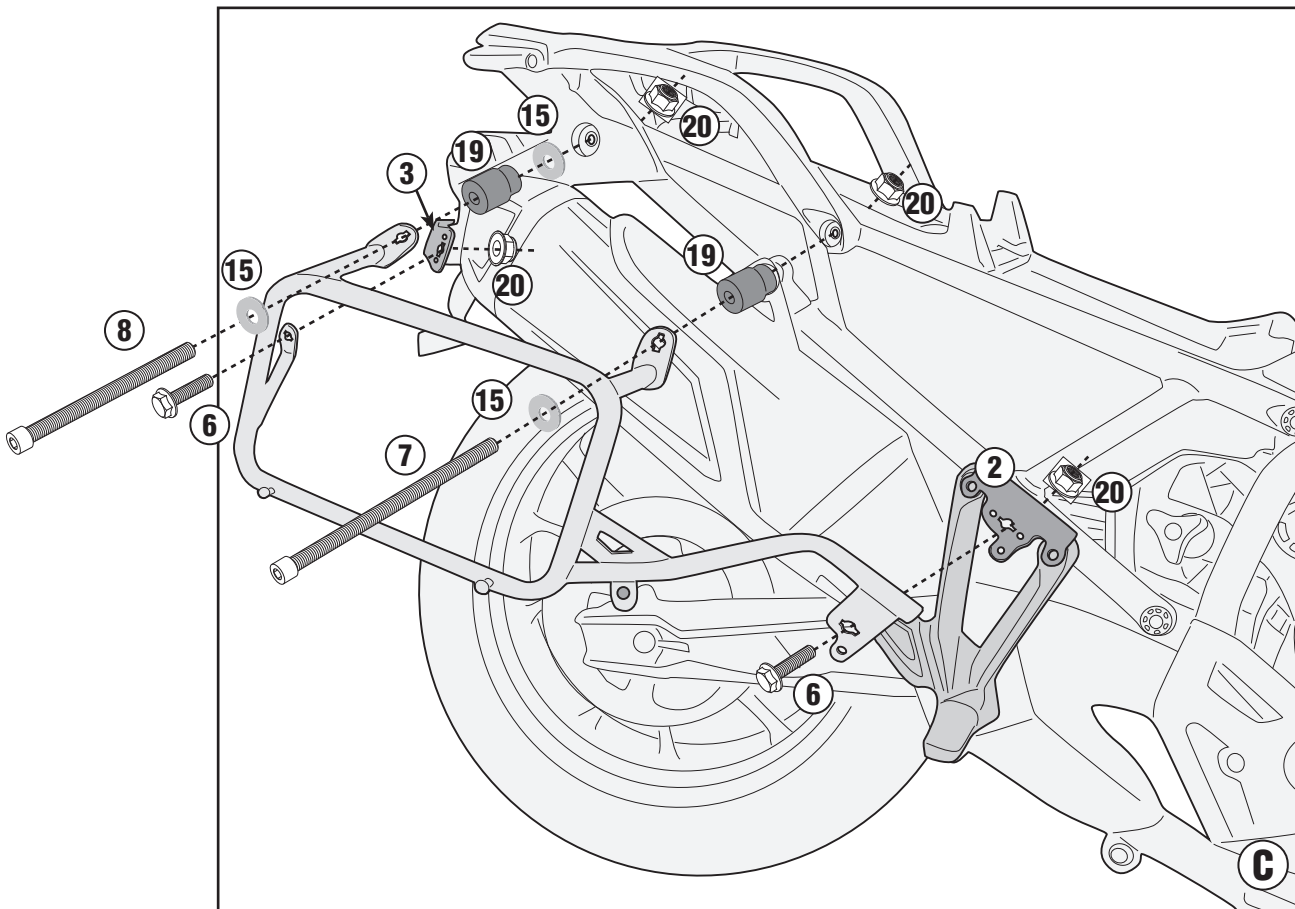
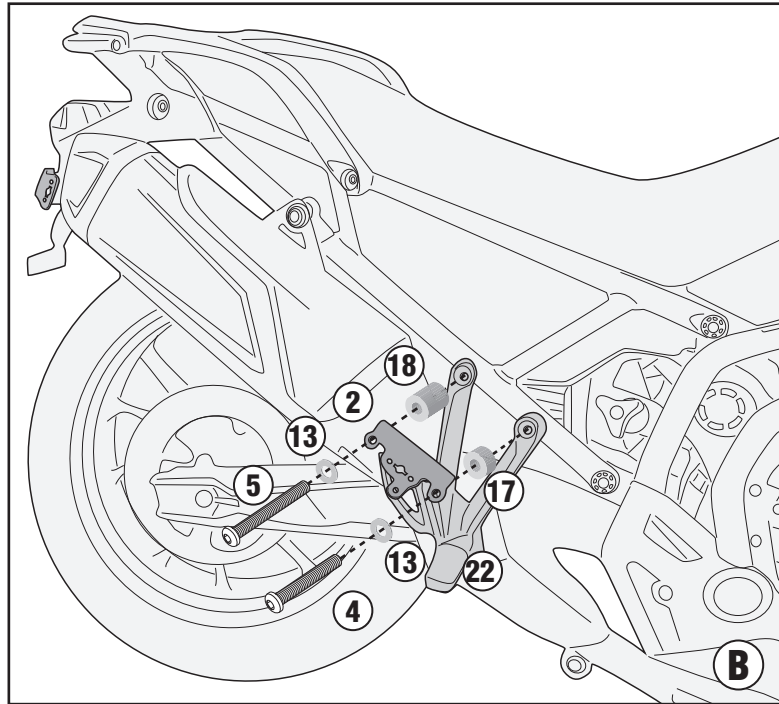

PL06415N - KL6415N

PORTAVALIGIE LATERALE SPECIFICO - SPECIFIC TUBULAR SIDE-CASE HOLDER - PORTE-VALISES LATÉRAUX SPÉCIFIQUE
SPEZIFISCHES STAHLROHR-SEITENTRÄGER - PORTA MALETAS LATERALES ESPECÍFICO - SUPORTE DE MALAS ESPECÍFICO

TRIUMPH TIGER 900 (2020)

- TRASFORMAZIONE IN PORTAVALIGIE LATERALI RAPID FITTING, AGGIUNDO IL KIT 01RKIT (DA ACQUISTARE SEPARATAMENTE)
- TRANSFORMATION INTO A RAPID FITTING SIDE-CASE HOLDER, BY ADDING THE 01RKIT KIT (TO BE PURCHASED SEPARATELY)
- VERARBEITUNG ZU EINEM SCHNELL MONTIERBAREN SEITENTRÄGER UNTER HINZUFÜGUNG DES 01RKIT-KITS (SEPARAT ZU ERWERBEN)
 - TRANSFORMABLE EN KIT DE FIXATION LATÉRAL RAPIDE, EN AJOUTANT LE KIT 01RKIT (À ACHETER SÉPARÉMENT)
- SE TRANSFORMA EN UN PORTAMALETAS LATERAL DE AJUSTE RÁPIDO, AÑADIENDO EL KIT 01RKIT (SE COMPRA POR SEPARADO)
- CONVERTE EM UM RACK DE PAINEL LATERAL DE ENCAIXE RÁPIDO, ADICIONANDO O KIT 01RKIT (ADQUIRIDO SEPARADAMENTE)

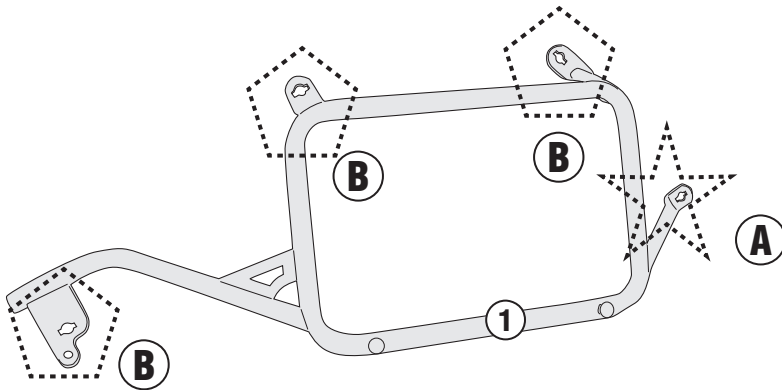

ALWAYS MOUNT THE SCREWS FROM THE OUTSIDE OF THE FRAME

★ TYPE A

(See the figure above for the correct type)

CORRECT SIDE



INSERT

ATTENTION TO THE
CORRECT ASSEMBLY

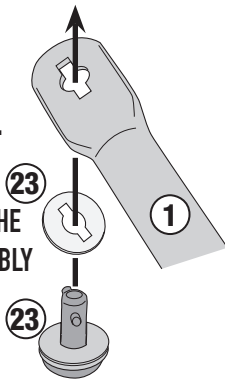

INSERT



ATTENTION TO THE
CORRECT ASSEMBLY

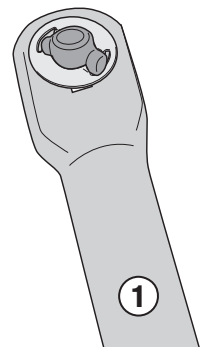
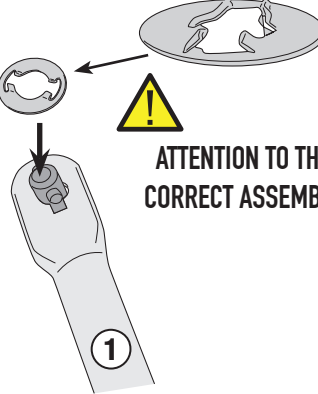

★ TYPE B

(See the figure above for the correct type)

CORRECT SIDE



INSERT

ATTENTION TO THE
CORRECT ASSEMBLY

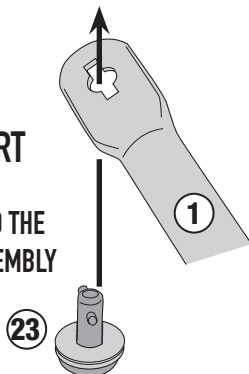

INSERT



ATTENTION TO THE
CORRECT ASSEMBLY

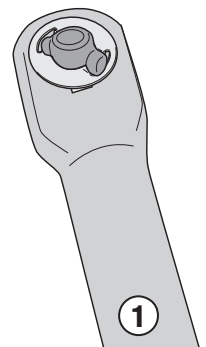
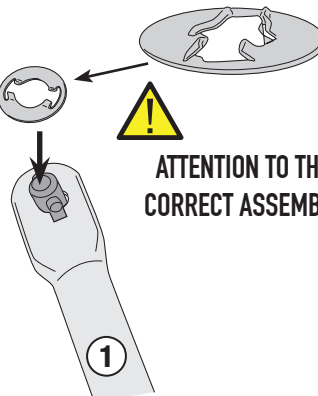

PL06415N - KL6415N

PORTAVALIGIE LATERALE SPECIFICO - SPECIFIC TUBULAR SIDE-CASE HOLDER - PORTE-VALISES LATÉRAUX SPÉCIFIQUE
SPEZIFISCHES STAHLROHR-SEITENTRAEGER - PORTA MALETAS LATERALES ESPECÍFICO - SUPORTE DE MALAS ESPECÍFICO

TRIUMPH TIGER 900 (2020)

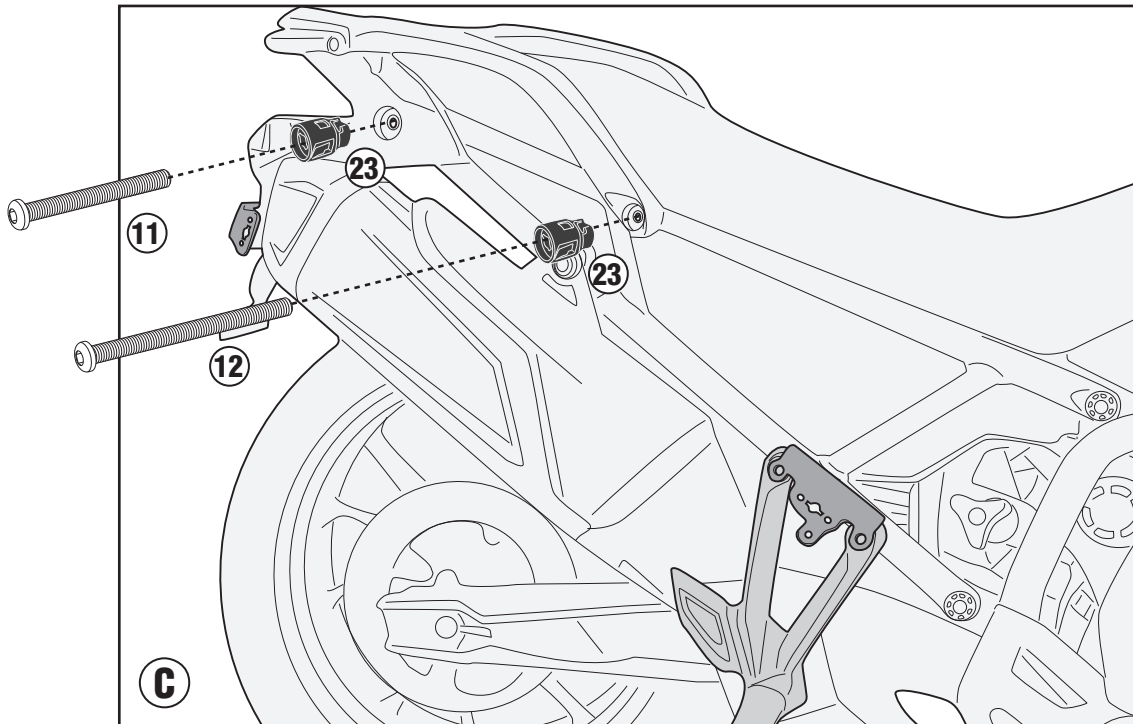
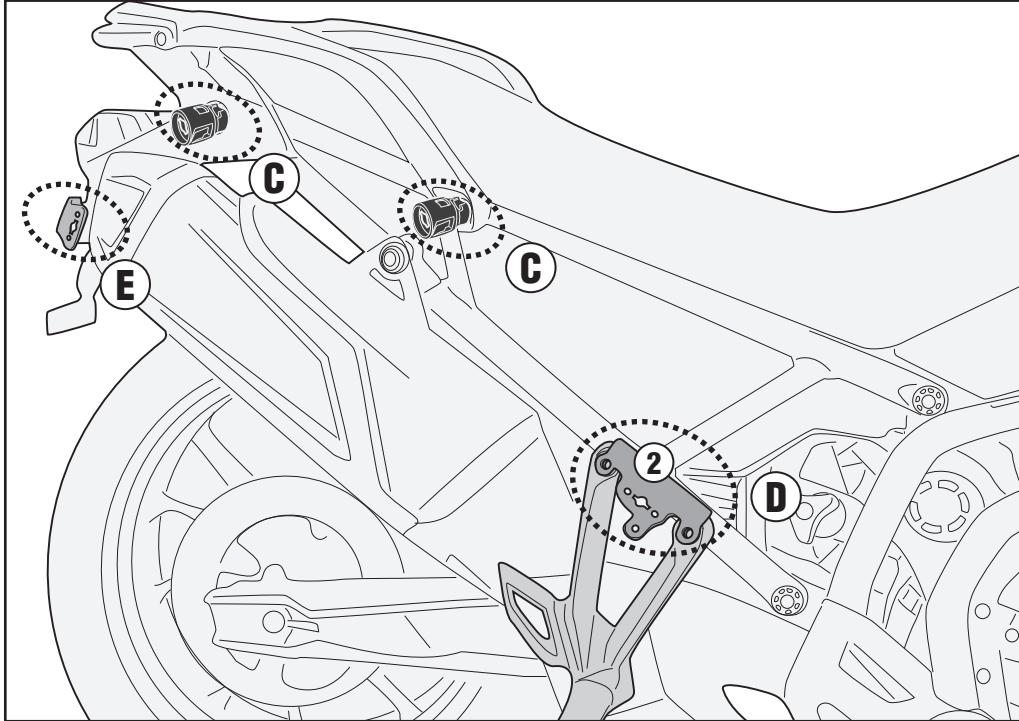

PL06415N - KL6415N

PORTAVALIGIE LATERALE SPECIFICO - SPECIFIC TUBULAR SIDE-CASE HOLDER - PORTE-VALISES LATÉRAUX SPÉCIFIQUE
 SPEZIFISCHES STAHLROHR-SEITENTRAEGER - PORTA MALETAS LATERALES ESPECÍFICO - SUORTE DE MALAS ESPECÍFICO

TRIUMPH TIGER 900 (2020)

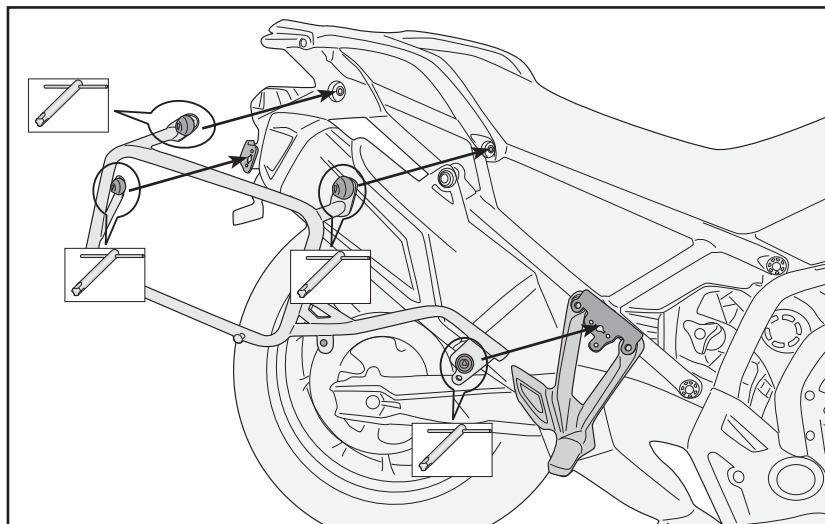
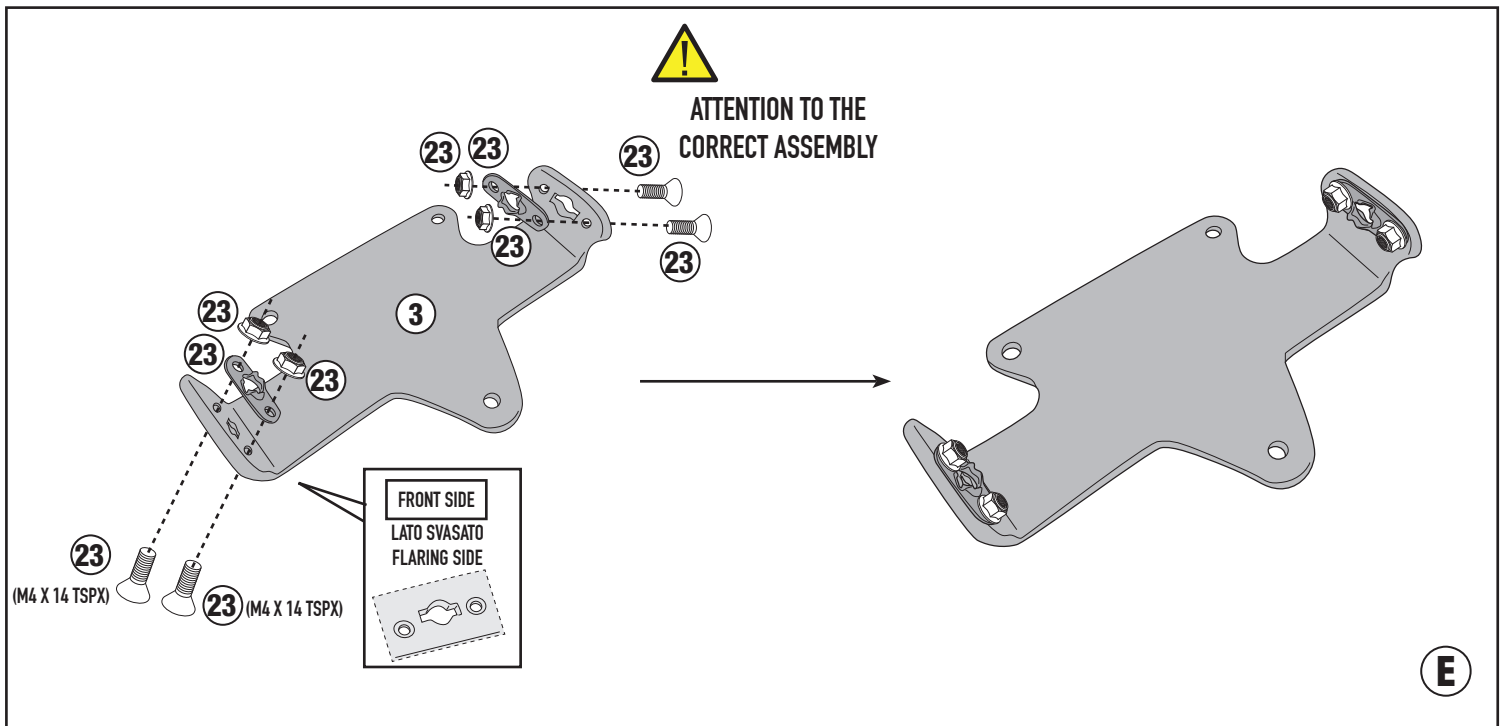
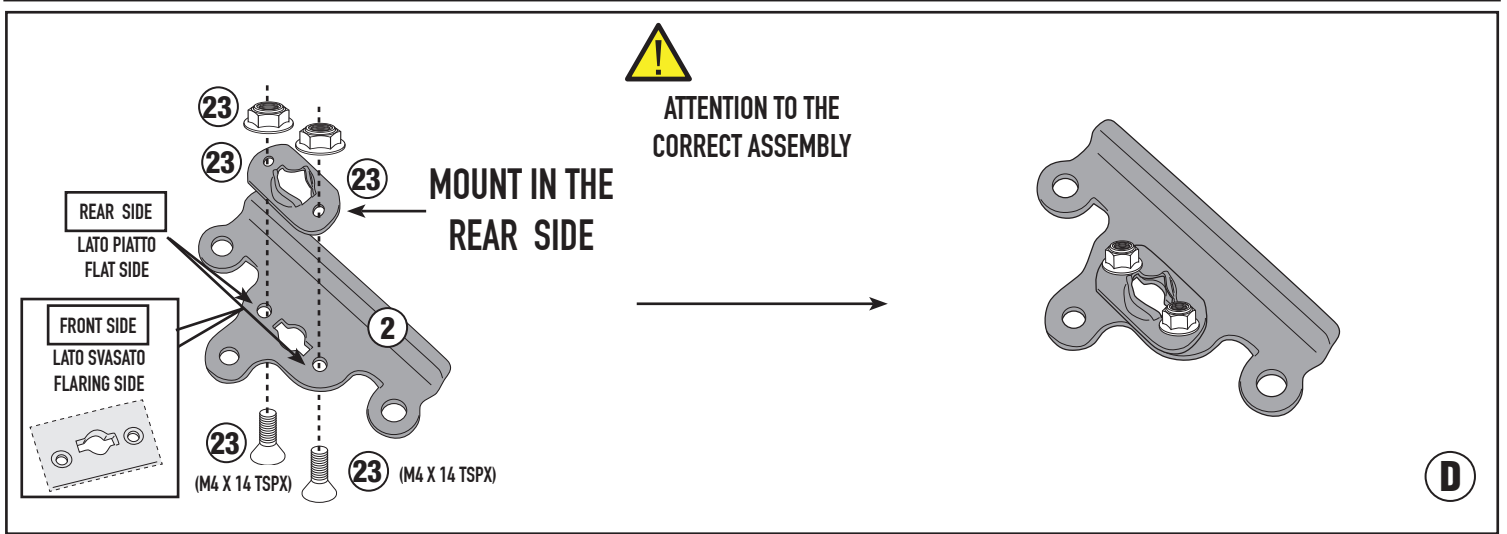

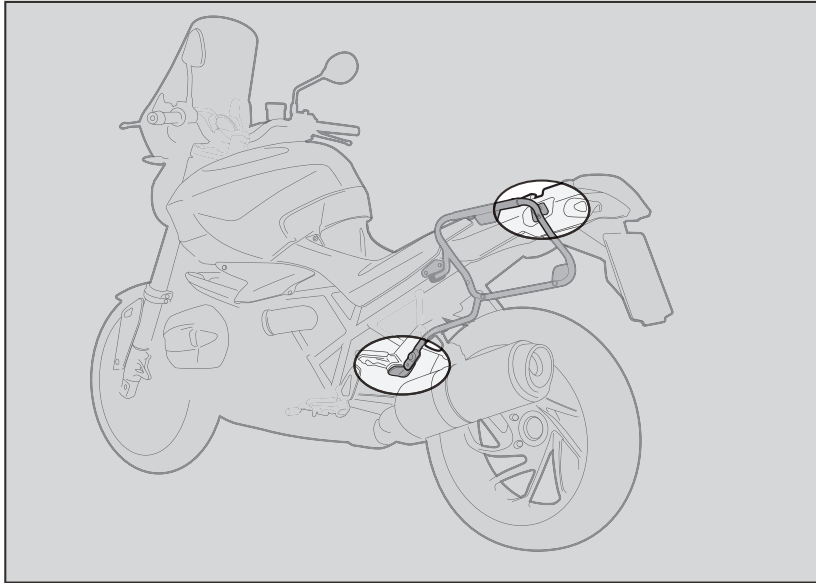

1. INSERIRE L'ATTREZZO NELLA TESTA DELLA VITE SPECIALE;
2. RUOTARE DI 1/4 DI GIRO IN SENSO ORARIO FINO A CHE LA ROTAZIONE NON TERMINA E SI AVVERTE LO SCATTO;
3. PER SMONTARE PROCEDERE IN SENSO INVERSO.

1. INSERT THE SPECIAL KEY INTO THE HEAD OF THE SCREW;
2. TURN THE KEY ¼ TURN CLOCKWISE UNTIL ROTATION STOPS AND THE SIDE CASE HOLDER IS FASTENED SECURELY TO THE FITMENT POINT;
3. IN ORDER TO DISASSEMBLE THE BRACKETRY PERFORM THE OPERATION IN REVERSE.

1. INSERER LA CLE SPECIALE DANS LA TÊTE DE LA VIS;
2. VISSER D'1/4 DE TOUR DANS LE SENS HORAIRE JUSQU'AU BLOCAGE DE LA VIS POUR MONTER EN TOUTE SECURITE LE SUPPORT A SON POINT DE FIXATION;
3. POUR LE DEMONTAGE, PROCEDER EN SENSE INVERSE.

1. STECKEN SIE DAS WERKZEUG IN DEN KOPF DER SPEZIFISCHEN SCHRAUBE;
2. DREHEN SIE DIE SCHRAUBE 1 / 4 UMDREHUNG IM UHRZEIGERSINN BIS SIE BEMERKEN, DASS DIE SCHRAUBE IM BEFESTIGUNGSPUNKT EINGEKLEMMT IST;
3. FÜR DIE DEMONTAGE FOLGEN SIE DEN HINWEISE UMGEKEHRT.

1. INSERTAR LA LLAVE ESPECIAL EN LA CABEZA DEL TORNILLO
2. DAR ¼ DE VUELTA EN EL SENTIDO HORARIO HASTA QUE LLEGUE AL TOPE Y SE VEA EL TORNILLO;
3. PARA DESMONTARLO PROCEDER EN LA DIRECCIÓN CONTRARIA;

MONTAGGIO - ASSEMBLY - MONTAGE - MONTAGE - MONTAJE

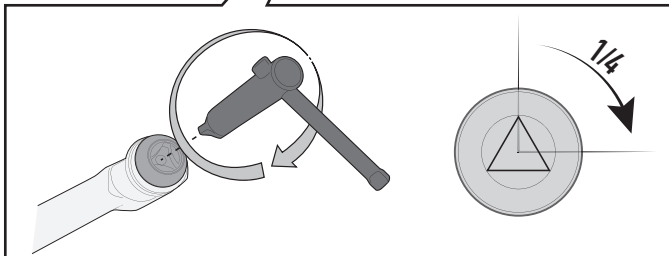
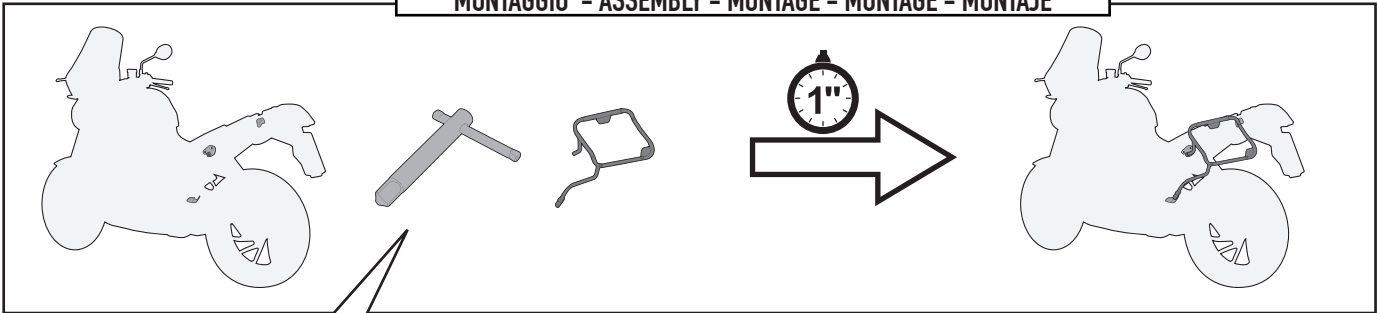

SMONTAGGIO - DISASSEMBLY - DÉMONTAGE - DEMONTAGE - DESMONTAJE

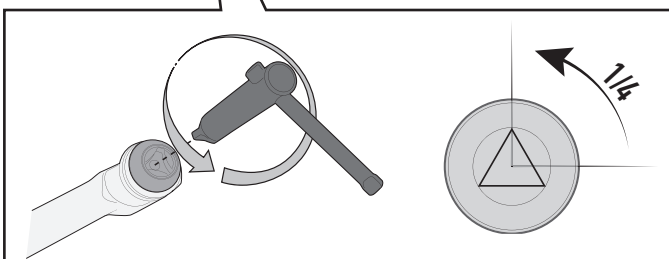
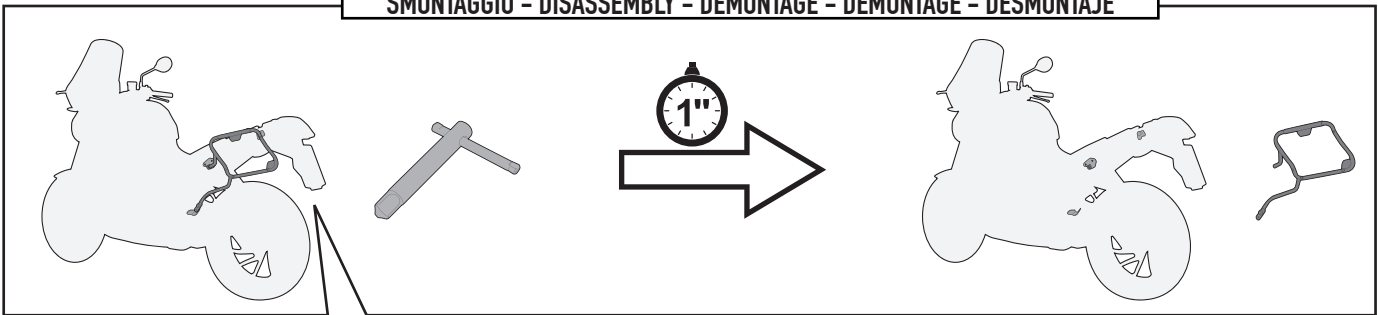

RAPID FITTING

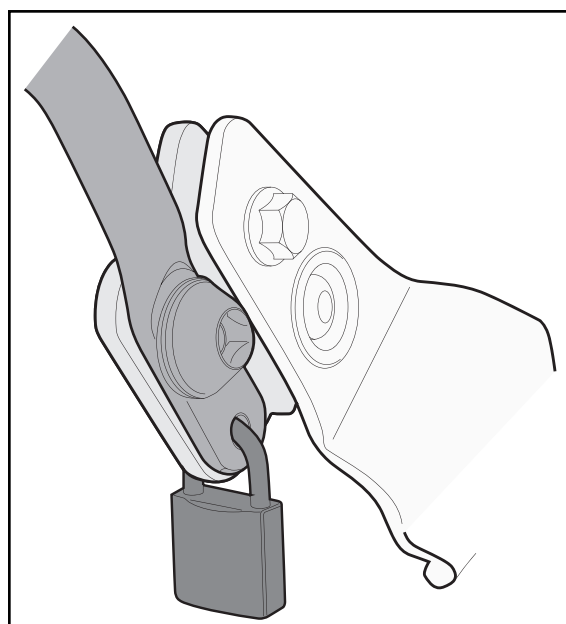
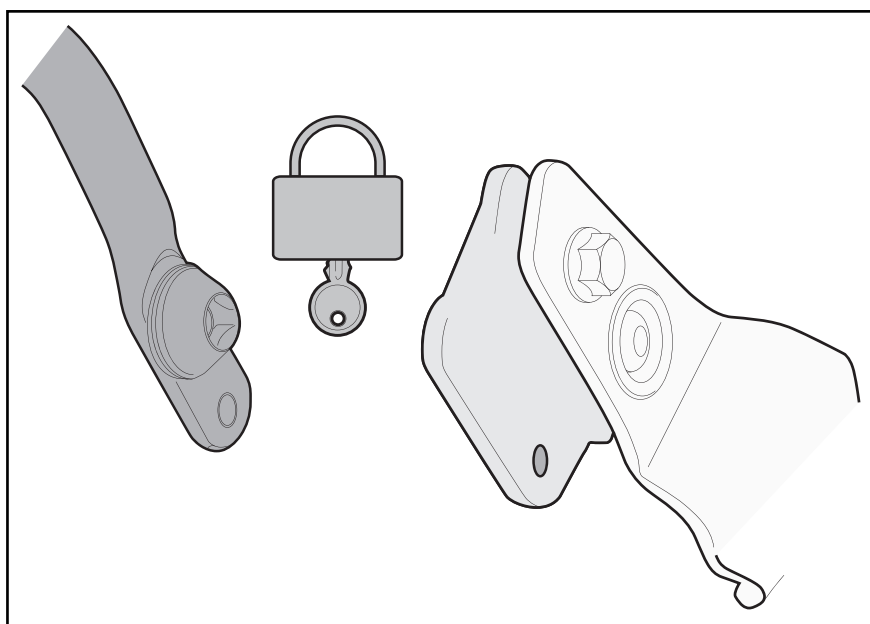
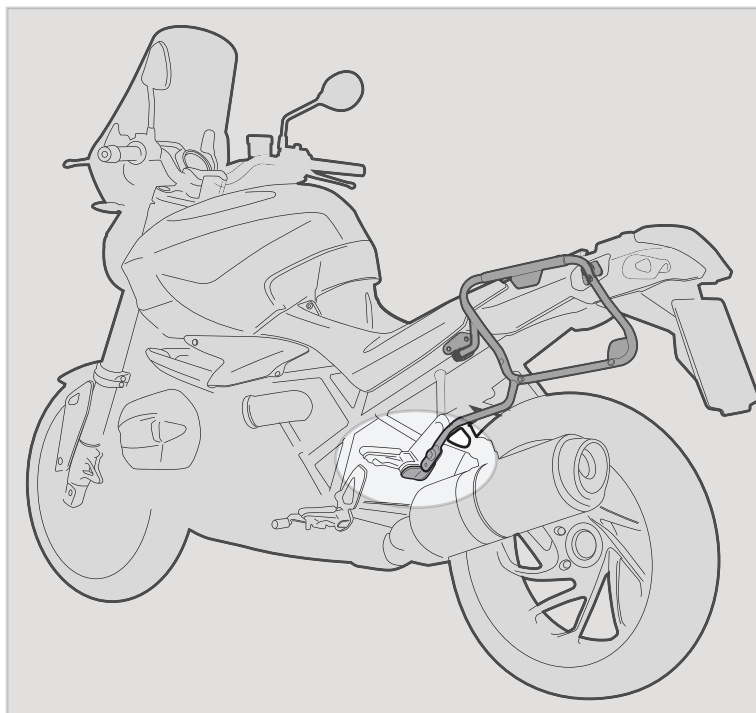

FORO DI SICUREZZA

FORO PREDISPOSTO AD ASSICURARE IL PORTAVALIGE LATERALE ALLA MOTO (CON UN LUCCHETTO PER ESEMPIO, NON INCLUSO).

SECURITY HOLE

HOLE PLACEMENT IN ORDER TO INCREASE SECURITY OF THE TUBULAR SIDE-CASE HOLDER TO THE MOTORCYCLE (WITH A LOCK, FOR EXAMPLE, NOT INCLUDED).

TROU DE SECURITE

TROU PREDISPOSE POUR ASSURER LE PORTE-VALISE LATERAL A LA MOTO (AVEC UN CADENAS PAR EXEMPLE, NON INCLUS).

SICHERHEITSLÖCH

VORGEGEHENES LOCH UM DEN SEITENKOFFER TRÄGER AN DEM FAHRZEUG ZU SICHERN (Z. B. MIT EINEM VORHÄNGESCHLOSS, NICHT ENTHALTEN);

ORIFICIO DE SEGURIDAD

ESTE ORIFICIO ESTA CREADO PARA ASEGURAR EL PORTAEQUIPAJES LATERAL A LA MOTO (POR EJEMPLO CON UN CANDADO, QUE NO ESTÁ INCLUIDO).